

2007

...and the trip goes on...

[®]**RIZOMA** made in Italy 
I N N O V A T I V E C O M P O N E N T S

rizoma: a tradition of quality



Aluminium is the third most common element on earth, after oxygen and silicon; in little more than ten years, its production on an industrial scale has revolutionised our way of living, thanks to its qualities of lightness, durability and strength.

There is not one industrial sector, from aerospace to motorcycles, in which aluminium does not make its presence felt; its "clean" appearance and its attributes make it extremely versatile.

At Rizoma, we began to exploit the qualities of this material as long ago as 1965 and since 1992 we have been manufacturing high-quality motorcycle components in aluminium or in alloy form that are particularly suitable for withstanding various mechanical stresses.

The use of such a valuable material supports a design range that pays great attention to detail and makes our accessories more practical as well as aesthetically convincing; development and testing stages enable us to achieve consistent manufacturing parameters and the approvals required.

Creation of the prototype assumes fundamental importance within the production process; it enables a full assessment to be made of any problems with the product to be marketed and to consider possible variations, modifications and improvements.

Racing experience



To improve the performance of our products, we rely on the racing experience of driver Dario Marchetti, winner of numerous trophies, not least that of the Daytona 2006 and of the Angaia Racing Team that has entered its drivers in the 125 cc and 250 cc world championships since 2000.



Close collaboration with the motorcycling teams allows us to try out improved solutions on a continuous basis and offer a product that is always state-of-the-art as regards performance and materials.

a unique style,
guaranteed.









The certification and approval given to many of our accessories, e.g. wing mirrors and state-of-the-art controls, constitute a fundamental stage in the production process; a product's certificate of conformity is undoubted evidence of high levels of practicality and performance. There is also a more aesthetic level of certification, one which confirms the uniqueness of a design, a demonstration of the uniqueness of our accessories, which makes our brand even more distinctive.

The items of our production are guaranteed for quality, resistance and durability. However they are not homologated for circulation on roads in countries where homologation is prescribed. Consequently RIZOMA® srl declines any sort of responsibility for different use made, asking also dealers to inform buyers of such limitations.

RIZOMA® srl has no connection with HONDA®, YAMAHA®, SUZUKI®, KAWASAKI®, KTM®, MV AGUSTA®, DUCATI®, HARLEY-DAVIDSON®, BUELL®, BMW®, TRIUMPH®, and/or their dealers. All items with trade mark, names or trade mark names for motorcycles identification are to be intended only as a reference for the use of some accessories of our production.

None of the images contained in this catalogue may be reproduced or republished.

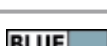
© 2007 Rizoma All rights reserved

	Products which have a "E-Homologation" included
	Products which have a TÜV-Approval included
	Accessories with design registration
	These mirrors are equipped with High-Quality "Convex" Mirror-Glasses for a optimal view.
	These mirrors are equipped with High-Quality "Blue Style" Mirror-Glasses for a more safety ride.
	Important notice
◀ year year ▶ year - year	up to... ...up from... to...

INDEX

■ ■ ■ universal

MIRRORS	8
MIRROR HOLE CAPS	28
FLUID TANKS	30
HANDLEBARS	32
HANDLEBAR CAPS	33
GRIPS	34
BRAKE / CLUTCH LEVERS	36
RISERS	40
INDICATOR LIGHTS	42
LICENSE PLATE SUPPORT LIGHTS	46
LICENSE PLATE SUPPORTS	48
REAR SET CONTROLS	52
PEGS	54
ENGINE / FAIRING GUARDS	58

■ ■ ■ sport bikes

BMW®	62
BUELL®	64
DUCATI®	68
HONDA®	80
KAWASAKI®	88
KTM®	98
MV AGUSTA®	100
SUZUKI®	102
TRIUMPH®	110
YAMAHA®	112

■ ■ ■ custom bikes

HARLEY-DAVIDSON®	128
HONDA®	134
YAMAHA®	136
GRIPS	144
RISERS / INDICATOR LIGHT CLAMPS	145
HANDLEBAR WATCHES	146



YAMAHA® FZ1



YAMAHA® YZF R6



HONDA® CBR 1000 RR



KAWASAKI® ZX-10R



SUZUKI® GSR 600



BMW® R1200S



and much more...

UNIVERSAL

A balance between design
and high-technology,
enhancement of details
and use of valuable materials;
our range of accessories
is designed to satisfy
the most diverse
of individual requirements.





RADIAL SPORT

- > Mirror approved in accordance with European regulations
- > Greater field of vision due to convex glass
- > Blue coloured antireflective glass
- > Registered design
- > Exclusive finish (registered)



BS130A



BS130B

CODE	COLOR	POSITION	PRICE (EACH)	ADAPTERS
BS130A	NATURAL	BIPOSITION	€ 129,00	PAGE 26
BS130B	BLACK	BIPOSITION	€ 129,00	PAGE 26

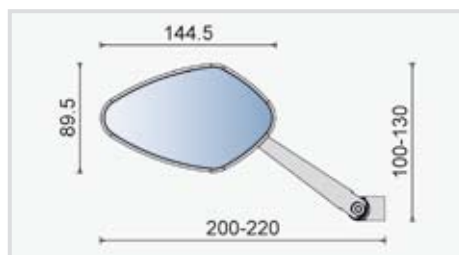

AVAILABLE FOR:

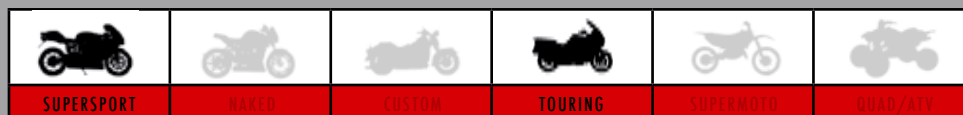



BS134A



BS134B



BS134BG

■ ■ ■ ■
RADIAL NAKED

- Mirror approved in accordance < with European regulations
- Greater field of vision < due to convex glass
- Blue coloured antireflective glass <
- Registered design <
- Exclusive finish (registered) <

CODE	COLOR	POSITION	PRICE (EACH)	ADAPTERS
BS134A	NATURAL	BIPOSITION	€ 129,00	PAGE 27
BS134B	BLACK	BIPOSITION	€ 129,00	PAGE 27
BS134BG	BICOLOR	BIPOSITION	€ 129,00	PAGE 27

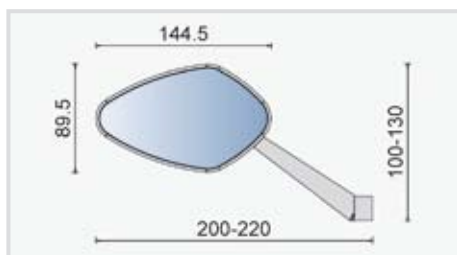

E **HOMOLOGATED**

CONVEX GLASS

BLUE GLASS COLOR

DESIGN REGISTRATION # 524939

AVAILABLE FOR:

SUPERSPORT	NAKED	CUSTOM	TOURING	SUPERMOTO	QUAD/ATV



LIMIT SPORT

- > Mirror approved in accordance with European regulations
- > Greater field of vision due to convex glass
- > Blue coloured antireflective glass
- > Registered design
- > Exclusive finish (registered)



BS150A



BS150B

CODE	COLOR	POSITION	PRICE (EACH)	ADAPTERS
BS150A	NATURAL	BIPOSITION	€ 149,00	PAGE 26
BS150B	BLACK	BIPOSITION	€ 149,00	PAGE 26

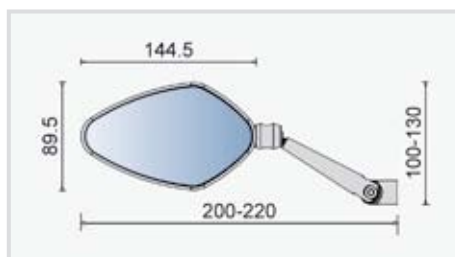

AVAILABLE FOR:

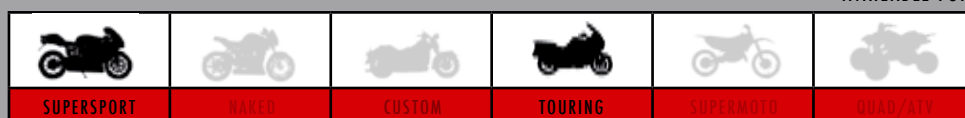



BS154A



BS154B

■ ■ ■ ■
LIMIT NAKED

Wing mirror approved in accordance <
with European regulations <
Greater field of vision <
due to convex glass <
Blue coloured antireflective glass <
Registered design <
Exclusive finish (registered) <

CODE	COLOR	POSITION	PRICE (EACH)	ADAPTERS
BS154A	NATURAL	BIPOSITION	€ 149,00	PAGE 27
BS154B	BLACK	BIPOSITION	€ 149,00	PAGE 27

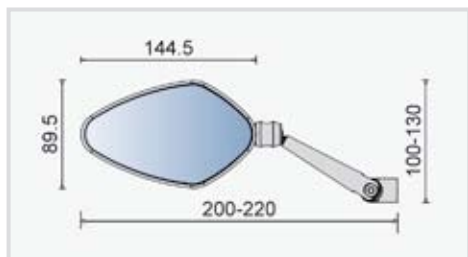

AVAILABLE FOR:

SUPERSPORT	NAKED	CUSTOM	TOURING	SUPERMOTO	QUAD/ATV



CLASS

- > Mirror approved in accordance with European regulations
- > Greater field of vision due to convex glass
- > Blue coloured antireflective glass
- > Registered design
- > Exclusive finish (registered)



BS140A



BS140B

CODE	COLOR	POSITION	PRICE (EACH)	ADAPTERS
BS140A	NATURAL	BIPOSITION	€ 89,00	PAGE 27
BS140B	BLACK	BIPOSITION	€ 89,00	PAGE 27

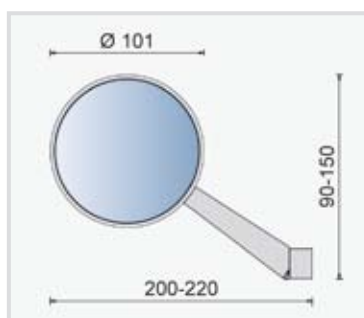

AVAILABLE FOR:

SUPERSPORT	NAKED	CUSTOM	TOURING	SUPERMOTO	QUAD/ATV





IMPULSIVE

- > Mirror approved in accordance with European regulations
- > Greater field of vision due to convex glass
- > Blue coloured antireflective glass



BS105A



BS105B

CODE	COLOR	POSITION	PRICE (EACH)	ADAPTERS
BS105A	GRIS	BIPOSITION	€ 89,00	PAGE 26-27
BS105B	BLACK	BIPOSITION	€ 89,00	PAGE 26-27

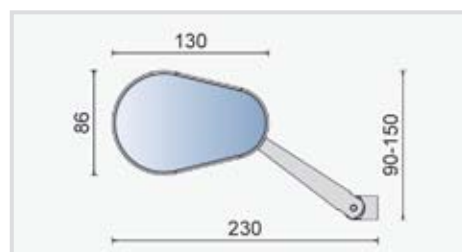

AVAILABLE FOR:

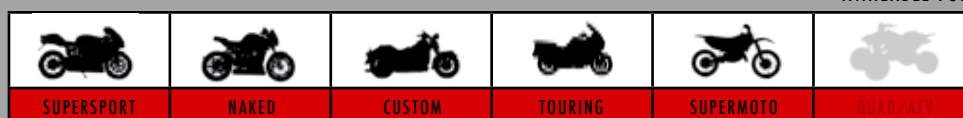



CLASS RETRO

- > Mirror approved in accordance with European regulations
- > Greater field of vision due to convex glass
- > Blue coloured antireflective glass

CODE	COLOR	POSITION	PRICE (EACH)	ADAPTERS
BS144A	NATURAL	BIPOSITION	€ 99,00	INCLUDED

FOR Ø 22-30 mm HANDLEBARS

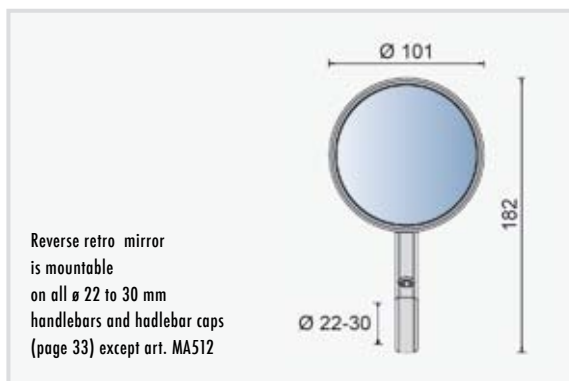

AVAILABLE FOR:

SUPERSPORT	NAKED	CUSTOM	TOURING	SUPERMOTO	QUAD/ATV



■ ■ ■ CIRCUIT 851

SCREWS INCLUDED
(10x1.25 - 10x1.25 sx - M8)



BS010A / BS011A



BS010B / BS011B



BS010L / BS011L

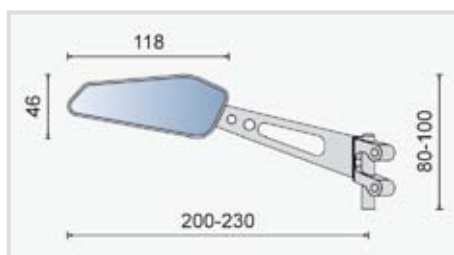

CODE	COLOR	POSITION	PRICE (EACH)	ADAPTERS
BS010A	GRIS	LEFT	€ 89,00	INCLUDED
BS010B	BLACK	LEFT	€ 89,00	INCLUDED
BS010L	POLISHED	LEFT	€ 89,00	INCLUDED
BS011A	GRIS	RIGHT	€ 89,00	INCLUDED
BS011B	BLACK	RIGHT	€ 89,00	INCLUDED
BS011L	POLISHED	RIGHT	€ 89,00	INCLUDED

* ADAPTER BS756B IS REQUIRED FOR BMW MODELS

BLUE
GLASS COLOR

AVAILABLE FOR:

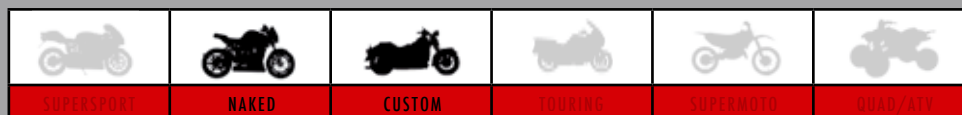



BS050A / BS052A



BS050B / BS052B



BS050L / BS052L

■ ■ ■ ■
AERO 17

Blue coloured antireflective glass <

CODE	COLOR	POSITION	PRICE (EACH)	ADAPTERS
BS050A	NATURAL	LEFT	€ 149,00	PAGE 26/27
BS050B	BLACK	LEFT	€ 149,00	PAGE 26/27
BS050L	POLISHED	LEFT	€ 149,00	PAGE 26/27
BS052A	NATURAL	RIGHT	€ 149,00	PAGE 26/27
BS052B	BLACK	RIGHT	€ 149,00	PAGE 26/27
BS052L	POLISHED	RIGHT	€ 149,00	PAGE 26/27

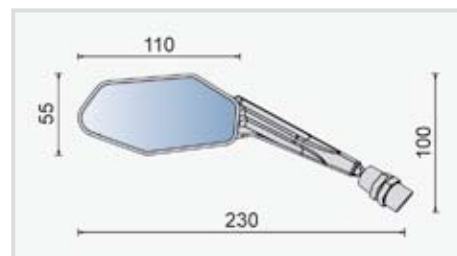

AVAILABLE FOR:

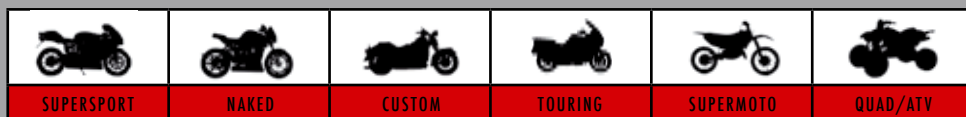



PROTOTYPE SPORT

> Blue coloured antireflective glass



BS110A / BS112A



BS110B / BS112B

CODE	COLOR	POSITION	PRICE (EACH)	ADAPTERS
BS110A	NATURAL	LEFT	€ 139,00	PAGE 26
BS110B	BLACK	LEFT	€ 139,00	PAGE 26
BS112A	NATURAL	RIGHT	€ 139,00	PAGE 26
BS112B	BLACK	RIGHT	€ 139,00	PAGE 26

BLUE
GLASS COLOR

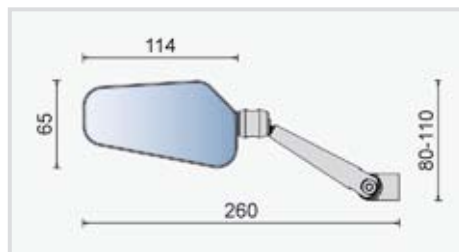

AVAILABLE FOR:

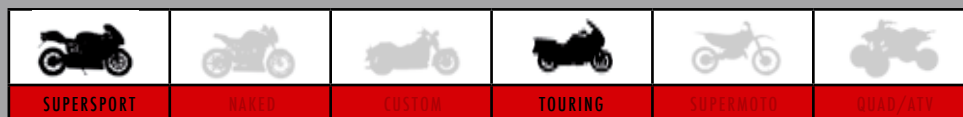



BS114A / BS116A



BS114B / BS116B



PROTOTYPE NAKED

Blue coloured antireflective glass <

CODE	COLOR	POSITION	PRICE (EACH)	ADAPTERS
BS114A	NATURAL	LEFT	€ 139,00	PAGE 27
BS114B	BLACK	LEFT	€ 139,00	PAGE 27
BS116A	NATURAL	RIGHT	€ 139,00	PAGE 27
BS116B	BLACK	RIGHT	€ 139,00	PAGE 27

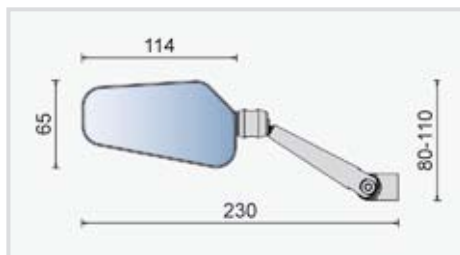

AVAILABLE FOR:





DYNAMIC

> Blue coloured antireflective glass



BS080A



BS080B



BS080L

CODE	COLOR	POSITION	PRICE (EACH)	ADAPTERS
BS080A	NATURAL	BIPOSITION	€ 65,00	PAGE 26/27
BS080B	BLACK	BIPOSITION	€ 65,00	PAGE 26/27
BS080L	POLISHED	BIPOSITION	€ 65,00	PAGE 26/27

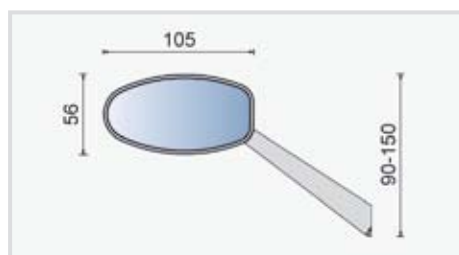

AVAILABLE FOR:

SUPERSPORT	NAKED	CUSTOM	TOURING	SUPERMOTO	QUAD/ATV



BS085A



BS085B



BS085L

LOGIC

Blue coloured antireflective glass <

CODE	COLOR	POSITION	PRICE (EACH)	ADAPTERS
BS085A	NATURAL	BIPOSITION	€ 65,00	PAGE 26/27
BS085B	BLACK	BIPOSITION	€ 65,00	PAGE 26/27
BS085L	POLISHED	BIPOSITION	€ 65,00	PAGE 26/27

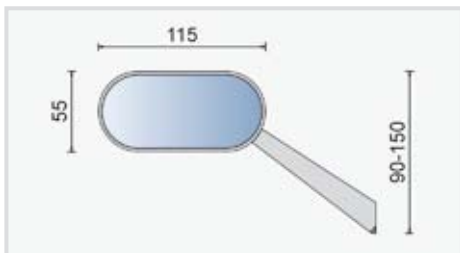

BLUE
GLASS COLOR

AVAILABLE FOR:

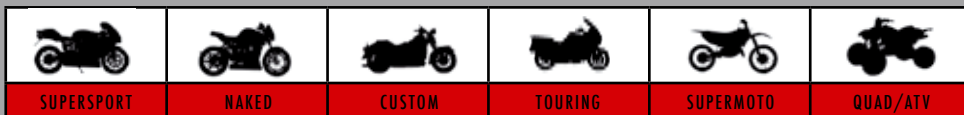



BS070A



BS070B



BS070L



REVERSE RETRO

Blue coloured antireflective glass <



CODE	COLOR	POSITION	PRICE (EACH)	ADAPTERS
BS070A	NATURAL	BIPOSITION	€ 82,00	INCLUDED
BS070B	BLACK	BIPOSITION	€ 82,00	INCLUDED
BS070L	POLISHED	BIPOSITION	€ 82,00	INCLUDED

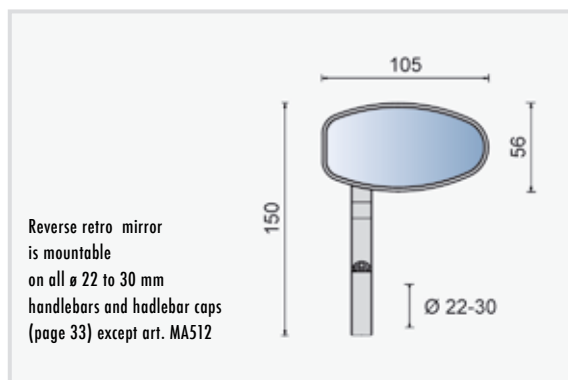

AVAILABLE FOR:

SUPERSPORT	NAKED	CUSTOM	TOURING	SUPERMOTO	QUAD/ATV

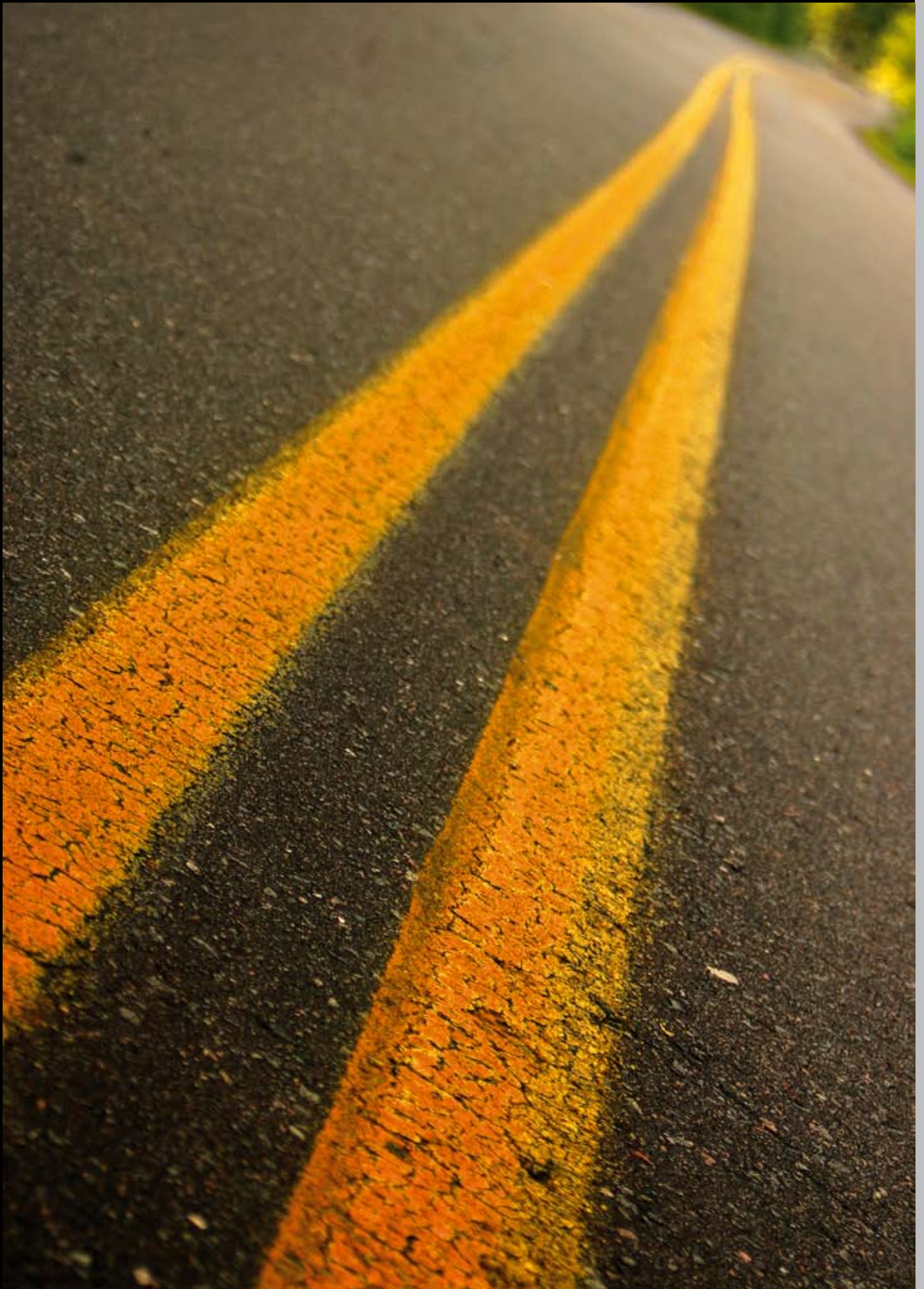



INVIDIA 2

The Invidia 2 can be adjusted to your ideal position using our innovative invisible sliding system.

Four positions are possible, with a minimum of 210 mm to a maximum of 240 mm.

SCREWS INCLUDED:
10x1.25
10x1.25 sx
M8

BLUE
GLASS COLOR



BS090B / BS092B



BS090L / BS092L

CODE	COLOR	POSITION	PRICE (EACH)	ADAPTERS
BS090B	BLACK	LEFT	€ 119,00	INCLUDED
BS090L	POLISHED	LEFT	€ 119,00	INCLUDED
BS092B	BLACK	RIGHT	€ 119,00	INCLUDED
BS092L	POLISHED	RIGHT	€ 119,00	INCLUDED

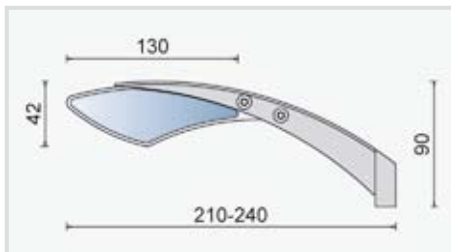

AVAILABLE FOR:

SUPERSPORT	NAKED	CUSTOM	TOURING	SUPERMOTO	QUAD/ATV



BS005B



BS005L

BLUE
GLASS COLOR

■■■■
INVIDIA

Blue coloured antireflective glass <

CODE	COLOR	POSITION	PRICE (EACH)	ADAPTERS
BS005B	BLACK	BIPOSITION	€ 79,00	INCLUDED
BS005L	POLISHED	BIPOSITION	€ 79,00	INCLUDED

SCREWS INCLUDED:
10x1.25
10x1.25 sx
M8

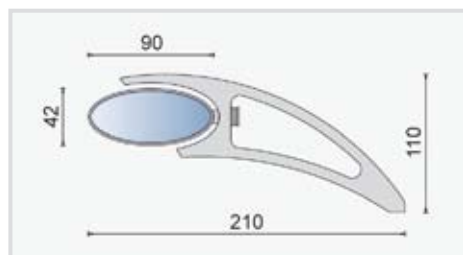

AVAILABLE FOR:

SUPERSPORT	NAKED	CUSTOM	TOURING	SUPERMOTO	QUAD/ATV

MIRROR ADAPTERS FOR BIKES WITH FRONT FAIRINGS



SOLD EACH
SCREWS INCLUDED

	BS720B
	BS721B
	BS722B
	BS723B
	BS724B
	BS726B
	BS728B

HONDA ■ ■ ■

MODEL	YEAR	CODE	COLOR	PRICE (EACH)
CBR600F	1999 ▶	BS720B	BLACK	€ 9,50
CBR600FS	2001-2002	BS720B	BLACK	€ 9,50
CBR600RR*	2003 ▶	BS721B	BLACK	€ 9,50
CBR1000RR*	2004 ▶	BS721B	BLACK	€ 9,50
VTR SP1	2000 ▶	BS720B	BLACK	€ 9,50
VTR SP2	2001 ▶	BS720B	BLACK	€ 9,50
CB600S HORNET	2003-2006	BS720B	BLACK	€ 9,50

* Adapter BS720B is required for BS050 and BS052 mirrors

KAWASAKI ■ ■ ■

MODEL	YEAR	CODE	COLOR	PRICE (EACH)
ZX-6R	◀ 2002	BS722B	BLACK	€ 9,50
ZX-6R	2003-2004	BS723B	BLACK	€ 9,50
ZX-6R	2005 ▶	BS721B	BLACK	€ 9,50
ZX-9R	◀ 2003	BS722B	BLACK	€ 9,50
ZX-10R	2004 ▶	BS721B	BLACK	€ 9,50
ER-6F	2006 ▶	BS723B	BLACK	€ 9,50
Z750S	2005-2006	BS723B	BLACK	€ 9,50

SUZUKI ■ ■ ■

MODEL	YEAR	CODE	COLOR	PRICE (EACH)
GSX-R 600	2001- 2005	BS726B	BLACK	€ 9,50
GSX-R 600	2006 ▶	BS728B	BLACK	€ 9,50
GSX-R 750	2001- 2005	BS726B	BLACK	€ 9,50
GSX-R 750	2006 ▶	BS728B	BLACK	€ 9,50
GSX-R 1000	2001-2004	BS726B	BLACK	€ 9,50
GSX-R 1000	2005 ▶	BS728B	BLACK	€ 9,50
SV650S	2001 ▶	BS726B	BLACK	€ 9,50
SV1000S	2001 ▶	BS726B	BLACK	€ 9,50
GSF 600 S BANDIT	2001 ▶	BS726B	BLACK	€ 9,50
GSF 1200 S BANDIT	2001 ▶	BS726B	BLACK	€ 9,50

YAMAHA ■ ■ ■

MODEL	YEAR	CODE	COLOR	PRICE (EACH)
YZF-R1	◀ 2001	BS722B	BLACK	€ 9,50
YZF-R1	2002 ▶	BS724B	BLACK	€ 9,50
YZF-R6	◀ 2005	BS722B	BLACK	€ 9,50
YZF-R6*	2006 ▶	BS724B	BLACK	€ 9,50
FZ1 FAZER	2006 ▶	BS734B	BLACK	€ 9,50

* Adapter BS722B is required for BS050 and BS052 mirrors

MIRROR ADAPTERS FOR NAKED BIKES

MODEL	YEAR	CODE	COLOR	PRICE (EACH)
ALL	ALL	BS711A	NATURAL	€ 9,50
ALL	ALL	BS711B	BLACK	€ 9,50



- SOLD EACH
- SCREWS:
10x1.25
10x1.25 sx
M8x50

OTHER BIKES

MODEL	YEAR	CODE	COLOR	PRICE (EACH)
MV AGUSTA BRUTALE 750	2002 ▶	BS730B	BLACK	€ 15,50
MV AGUSTA BRUTALE 910	2005 ▶	BS730B	BLACK	€ 15,50
SUZUKI BANDIT 600	2000 ▶	BS727B	BLACK	€ 15,50
SUZUKI BANDIT 1200	2000 ▶	BS727B	BLACK	€ 15,50
BMW K1200R	2005 ▶	BS752B	BLACK	€ 15,50
BMW K1200GS	2005 ▶	BS752B	BLACK	€ 15,50
BMW OTHERS MODELS	ALL	BS750B	BLACK	€ 15,50



MIRROR HOLE CAPS



PAIR - SCREWS INCLUDED

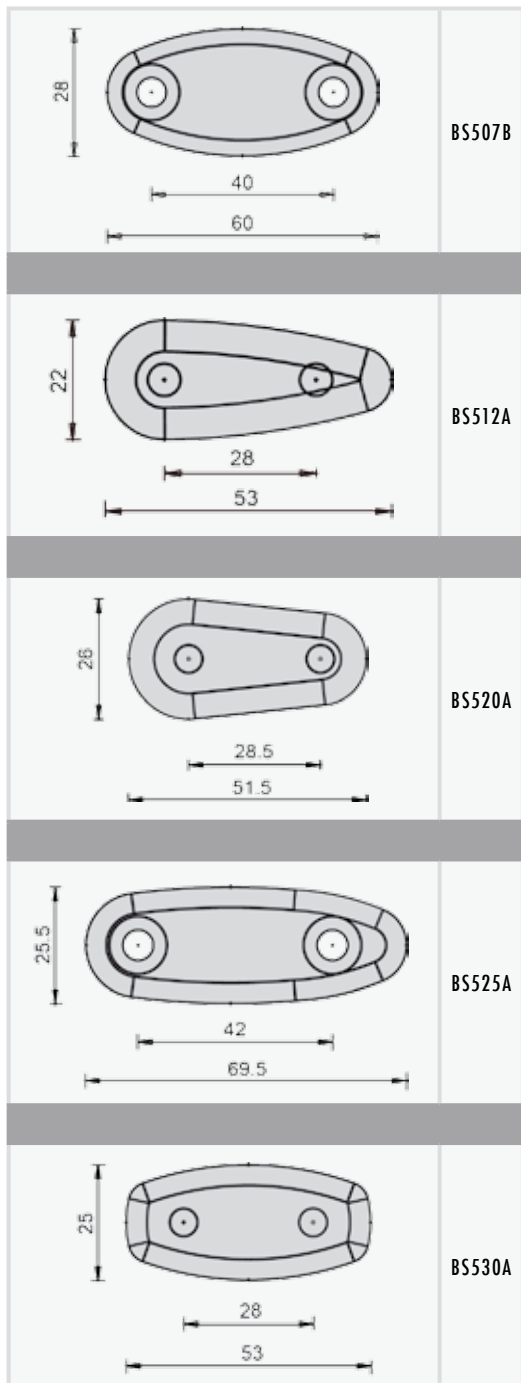

HONDA ■ ■ ■

MODEL	YEAR	CODE	COLOR	PRICE (PAIR)
CB600S HORNET	2003 ▶	BS507B	BLACK	€ 24,00
CBR600F	1999 ▶	BS507B	BLACK	€ 24,00
CBR600FS	2001-2002	BS507B	BLACK	€ 24,00
CBR600RR	2004 ▶	BS507B	BLACK	€ 24,00
CBR1000RR	2003 ▶	BS507B	BLACK	€ 24,00
CBR900	200-2004	BS507B	BLACK	€ 24,00
VTR SP1	2000 ▶	BS507B	BLACK	€ 24,00
VTR SP2	2001 ▶	BS507B	BLACK	€ 24,00

KAWASAKI ■ ■ ■

MODEL	YEAR	CODE	COLOR	PRICE (PAIR)
Z750S	2005 ▶	BS530B	BLACK	€ 24,00
ZX-6R 636	◀ 2002	BS512B	BLACK	€ 24,00
ZX-6R 636	2003-2004	BS530B	BLACK	€ 24,00
ZX-6R 636	2005 ▶	BS507B	BLACK	€ 24,00
ZX-9R	◀ 2003	BS512B	BLACK	€ 24,00
ZX-10R	2004 ▶	BS507B	BLACK	€ 24,00

SUZUKI ■ ■ ■

MODEL	YEAR	CODE	COLOR	PRICE (PAIR)
GSX-R 600	2001 ▶	BS525B	BLACK	€ 24,00
GSX-R 750	2001 ▶	BS525B	BLACK	€ 24,00
GSX-R 1000	2001-2004	BS525B	BLACK	€ 24,00
GSX-R 1000	2005 ▶	BS507B	BLACK	€ 24,00
SV650S	2001 ▶	BS525B	BLACK	€ 24,00
SV1000S	2001 ▶	BS525B	BLACK	€ 24,00
GSF600S BANDIT	2001 ▶	BS525B	BLACK	€ 24,00
GSF1200S BANDIT	2001 ▶	BS525B	BLACK	€ 24,00

YAMAHA ■ ■ ■

MODEL	YEAR	CODE	COLOR	PRICE (PAIR)
FZS 1000	◀ 2005	BS500B	BLACK	€ 24,00
FZ1 FAZER	2006 ▶	BS525B	BLACK	€ 24,00
YZF-R1	◀ 2001	BS512B	BLACK	€ 24,00
YZF-R1	2002 ▶	BS520B	BLACK	€ 24,00
YZF-R6	◀ 2001	BS512B	BLACK	€ 24,00
YZF-R6	2002 ▶	BS520B	BLACK	€ 24,00

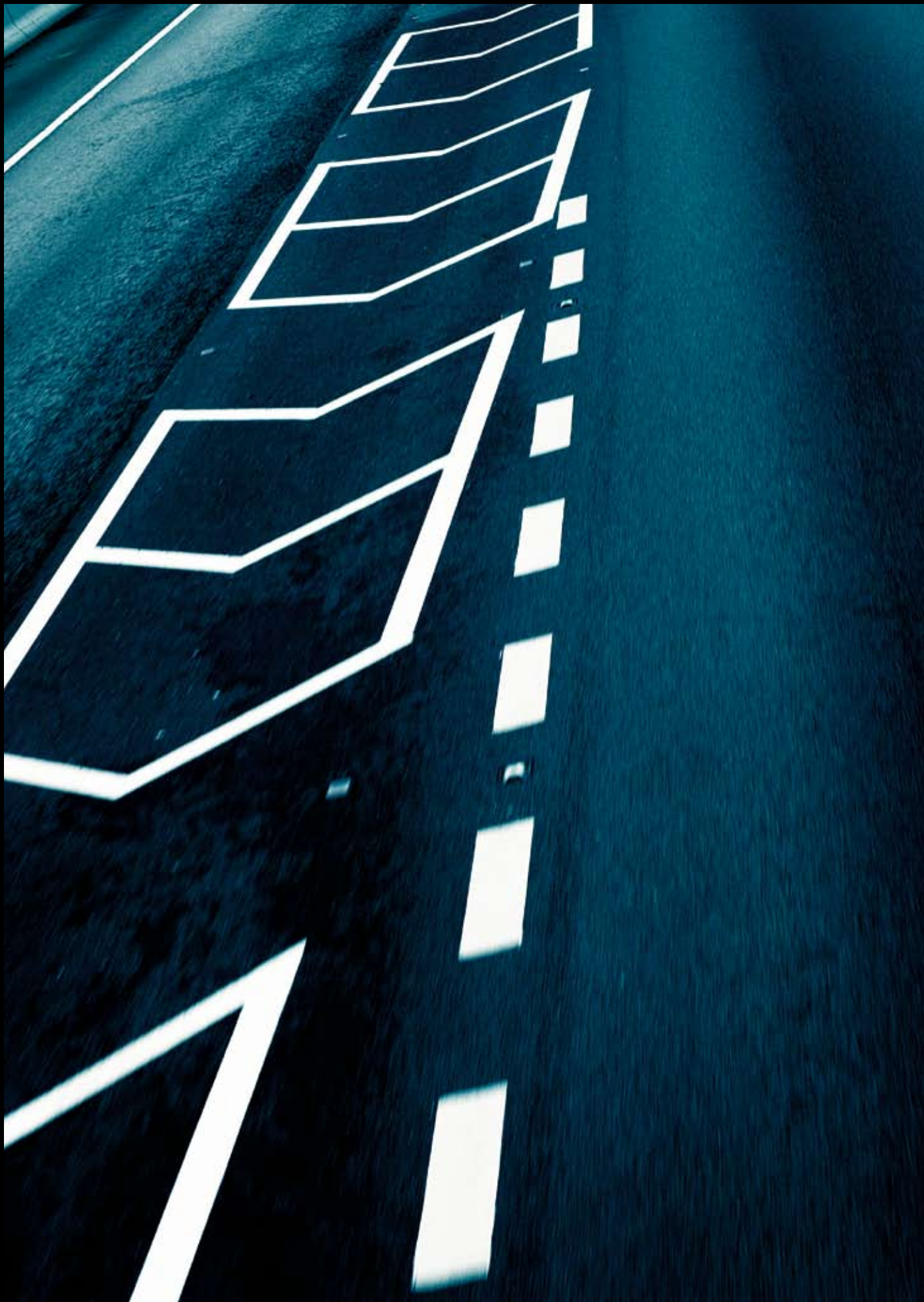

FLUID TANKS

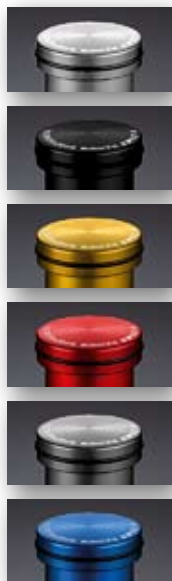

DESIGN
REGISTRATION
524939

VOLUME	20 mm ³
HEIGHT	42 mm
DIAMETER	31 mm

CODE	COLOR	PRICE
CT015A	NATURAL	€ 39,00
CT015B	BLACK	€ 39,00
CT015G	GOLD	€ 39,00
CT015R	RED	€ 39,00
CT015T	TITANIUM	€ 39,00
CT015U	BLUE	€ 39,00



DESIGN
REGISTRATION
524939

VOLUME	26 mm ³
HEIGHT	49 mm
DIAMETER	40 mm

CODE	COLOR	PRICE
CT017A	NATURAL	€ 56,00
CT017B	BLACK	€ 56,00
CT017G	GOLD	€ 56,00
CT017R	RED	€ 56,00
CT017T	TITANIUM	€ 56,00
CT017U	BLUE	€ 56,00

FLUID TANKS

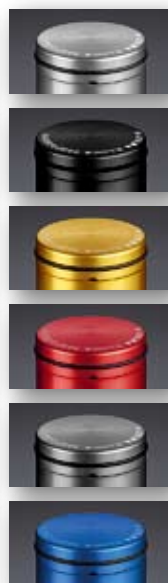

CODE	COLOR	PRICE
CT025A	NATURAL	€ 56,00
CT025B	BLACK	€ 56,00
CT025G	GOLD	€ 56,00
CT025R	RED	€ 56,00
CT025T	TITANIUM	€ 56,00
CT025U	BLUE	€ 56,00

VOLUME	27 mm ³
HEIGHT	49 mm
DIAMETER	40 mm

DESIGN
REGISTRATION
524939

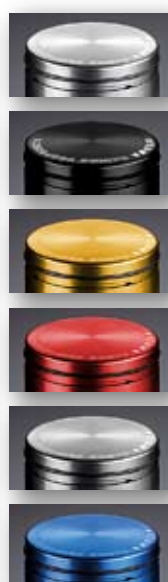

CODE	COLOR	PRICE
CT027A	NATURAL	€ 59,00
CT027B	BLACK	€ 59,00
CT027G	GOLD	€ 59,00
CT027R	RED	€ 59,00
CT027T	TITANIUM	€ 59,00
CT027U	BLUE	€ 59,00

VOLUME	35 mm ³
HEIGHT	43 mm
DIAMETER	50 mm

DESIGN
REGISTRATION
524939

HANDLEBARS

conical handlebar, Ø 22-29 mm ■ ■ ■

CODE	COLOR	PRICE
MA005A	NATURAL	€ 89,00
MA005B	BLACK	€ 89,00
MA005G	GOLD	€ 89,00
MA005R	RED	€ 89,00
MA005U	BLUE	€ 89,00

Variable section handlebar, the most elegant and effective means of reducing vibration.

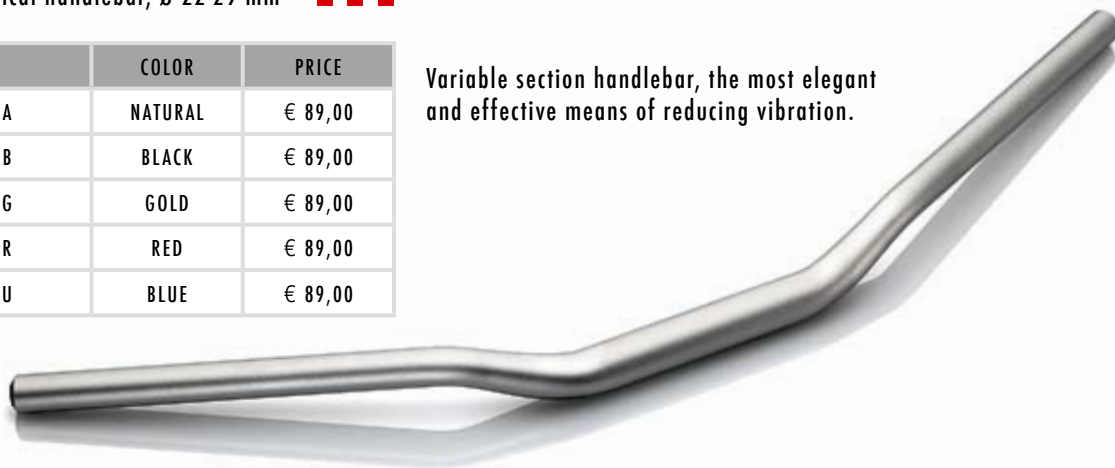

WEIGHT 0.56 Kg

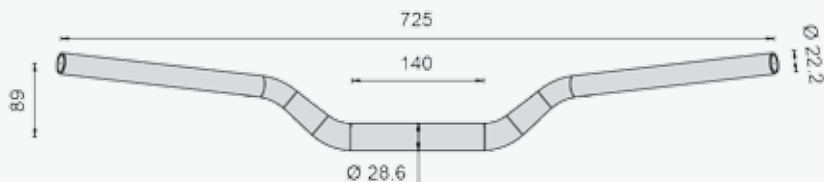

handlebar, Ø 22 mm ■ ■ ■

CODE	COLOR	PRICE
MA001A	NATURAL	€ 49,00
MA001B	BLACK	€ 49,00
MA001G	GOLD	€ 49,00
MA001R	RED	€ 49,00
MA001U	BLUE	€ 49,00



WEIGHT 0.46 Kg

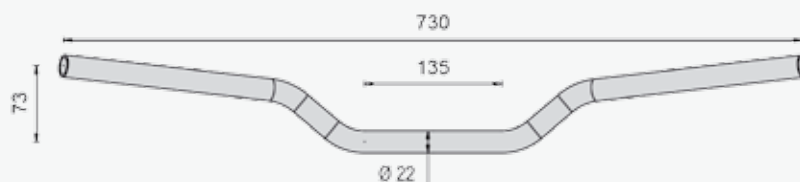

HANDLEBARS



■ ■ ■ handlebar caps

CODE	COLOR	PRICE (PAIR)
MA512A	NATURAL	€ 49,00
MA512B	BLACK	€ 49,00
MA512G	GOLD	€ 49,00
MA512R	RED	€ 49,00
MA512U	BLUE	€ 49,00

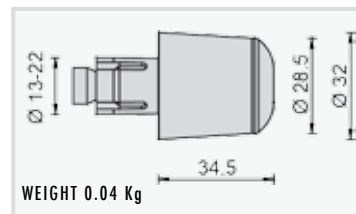

DESIGN
REGISTRATION
524939

MA512 cannot be used in combination with BS070 and BS144 mirrors.

■ ■ ■ handlebar caps



CODE	COLOR	PRICE (PAIR)
MA506A	NATURAL	€ 39,00
MA506B	BLACK	€ 39,00
MA506G	GOLD	€ 39,00
MA506R	RED	€ 39,00
MA506U	BLUE	€ 39,00

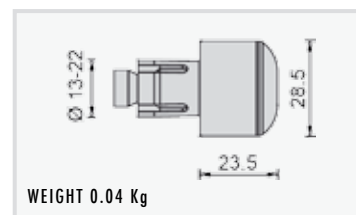

DESIGN
REGISTRATION
524939

■ ■ ■ handlebar caps



CODE	COLOR	PRICE (PAIR)
MA502A	NATURAL	€ 29,00
MA502B	BLACK	€ 29,00
MA502G	GOLD	€ 29,00
MA502R	RED	€ 29,00
MA502U	BLUE	€ 29,00

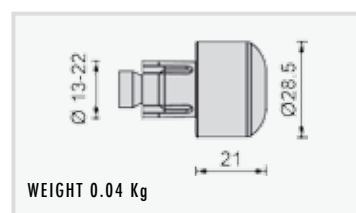

GRIPS



sport line ■ ■ ■

The shapes of the Rizoma universal grips and the range of anodised finishes are strong aesthetic features. The 2007 edition of this item sees an improvement in the quality of materials used: The rubber hand-grip is all new, produced using a new mould and offers improved grip and longer life. The cable stays are included in the kit.

CODE	COLOR	PRICE (PAIR)
GR205A	NATURAL	€ 49,00
GR205B	BLACK	€ 49,00
GR205G	GOLD	€ 49,00
GR205R	RED	€ 49,00
GR205U	BLUE	€ 49,00

Adapters for all bike models are included, except for MV AGUSTA

GR414B grips adapters for MV AGUSTA BRUTALE

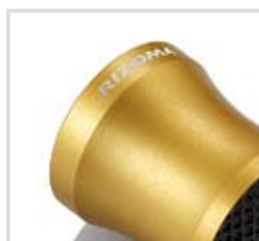
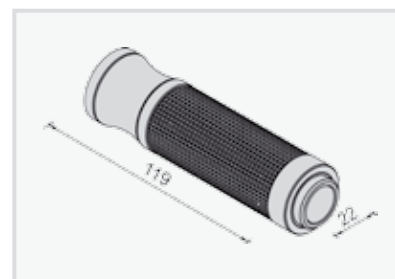



U
N
I
V
E
R
S
I
T
Y

UNIVERSAL



BRAKE/CLUTCH LEVERS

DESIGN
REGISTRATION
524939



BRAKE LEVER



Never again under pressure

Braking is one of key events in driving, on the track as it is on the road, an event that puts the driver under pressure and requires constant perfection in concentration, practice, vision and controls. Drivers in "heroic" times usually put adhesive tape on the brake lever, so that they always had the very best hand grip when dethrottling.

Today, necessity and technology have changed but the front brake lever is still of fundamental importance, especially with the use of modern radial callipers, with additional aesthetic requirements. This is why Rizoma has created its new, patented design, brake lever, which is above all aerodynamic.

Extensive wind tunnel studies have shown that at speeds above 180 km per hour, the force of the air causes movement of the lever, which puts the hydraulic circuit under pressure, limiting the bike's performance. Rizoma has therefore strived to reduce this detrimental effect to the minimum.



Aesthetics and practicality are naturally of the highest order, in accordance with Rizoma traditions; the lever is shaped from the solid and anodised in three colours, (black, gold and natural billet).

The design of the system is the result of very thorough research, which led the company to decide to patent it.

From the practical point of view, there are ultrafine lines on the front to give the driver's hand the right degree of grip and an articulated joint to avoid breakage in the event of a slide.

The technology used in the construction is of the highest order; the lever offers a wide range of adjustment and moves on bearings with return springs specifically for operational precision, reliability and durability.

Variable section handlebar, the most elegant and effective means of reducing vibration



CLUTCH LEVER



Aerodynamic, for no... slipping

On the modern motorcycle the clutch can be used much less than it used to be but, in spite of progress and development, it is still a very important device. Studies have shown that at high speeds the air pressure acts on the lever so as to put the circuit under pressure, rendering it non-operational. (hydraulic clutch).

On the modern motorcycle the clutch can be used much less than it used to be. Changing with controls that are ever more precise and smooth make it almost superfluous even uphill, making its use strictly necessary only when moving off. The mechanical element, however, continues to play a fundamental role in the transmission of power from the engine to the wheel. And it has a major enemy: speed. Studies have shown that, at speeds above 180 km per hour, the air pressure acts on the lever so as to put the circuit under pressure in the case of clutches with hydraulic controls. That entails a risk of abnormal clutch wear, which can cause slippage and wear out the discs.

Rizoma's beautiful new clutch lever drastically reduces this negative effect. The subject of much wind tunnel research, it was modified several times to make it less sensitive to air pressure, even at very high speeds, an important achievement, which led the company to decide to patent the original design. Rizoma's Super-sport lever represents the state of the art today and is perfectly suited to supersport bikes, in particular very high performance 1000 cc superbikes, especially for track use.

Another prerogative of this new product, which has always been an exponent of Rizoma's philosophy, is the highest level of care that accompanies the manufacture of light alloy components, and their assembly. This is shown not only by the quality of the finishes but also by the care taken in the search for maximum practicality. One only has to consider the ultrafine lines on the front to give increased grip, the adjustment options and the articulated joint that avoids breakage in the event of a slide. Rizoma's Super-sport clutch lever is available in three anodised colours: black, natural billet and gold.

BRAKE/CLUTCH LEVERS

DESIGN
REGISTRATION
524939

■ ■ ■ BUELL

MODEL	YEAR	BRAKE LEVER				CLUTCH LEVER			
		NATURAL	BLACK	GOLD	PRICE	NATURAL	BLACK	GOLD	PRICE
XB9R-XB9SX	2003 ▶	LB550A	LB550B	LB550G	€ 169,00	LC550A	LC550B	LC550G	€ 129,00
XB9SX	2004 ▶	LB550A	LB550B	LB550G	€ 169,00	LC550A	LC550B	LC550G	€ 129,00
XB12R-XB12S	2003 ▶	LB550A	LB550B	LB550G	€ 169,00	LC550A	LC550B	LC550G	€ 129,00
XB12SS	2005 ▶	LB550A	LB550B	LB550G	€ 169,00	LC550A	LC550B	LC550G	€ 129,00
XB12X	2006 ▶	LB550A	LB550B	LB550G	€ 169,00	LC550A	LC550B	LC550G	€ 129,00
XB12STT	2007 ▶	LB550A	LB550B	LB550G	€ 169,00	LC550A	LC550B	LC550G	€ 129,00

■ ■ ■ DUCATI

MODEL	YEAR	BRAKE LEVER				CLUTCH LEVER			
		NATURAL	BLACK	GOLD	PRICE	NATURAL	BLACK	GOLD	PRICE
MONSTER 620	01-06	LB502A	LB502B	LB502G	€ 169,00	LC502A	LC502B	LC502G	€ 169,00
MONSTER 695	2006 ▶	LB502A	LB502B	LB502G	€ 169,00	LC502A	LC502B	LC502G	€ 169,00
MONSTER 750	96-02	LB502A	LB502B	LB502G	€ 169,00	LC502A	LC502B	LC502G	€ 169,00
MONSTER S2R	2005 ▶	LB502A	LB502B	LB502G	€ 169,00	LC502A	LC502B	LC502G	€ 169,00
MONSTER 1000	03-05	LB501A	LB501B	LB501G	€ 169,00	LC501A	LC501B	LC501G	€ 169,00
MONSTER S2R 1000	2006 ▶	LB501A	LB501B	LB501G	€ 169,00	LC501A	LC501B	LC501G	€ 169,00
MONSTER S4R	04-06	LB501A	LB501B	LB501G	€ 169,00	LC501A	LC501B	LC501G	€ 169,00
MONSTER S4R/S4RS TESTA STRETTA	2006 ▶	LB500A	LB500B	LB500G	€ 169,00	LC500A	LC500B	LC500G	€ 169,00
MULTISTRADA 620	2006 ▶	LB502A	LB502B	LB502G	€ 169,00	LC502A	LC502B	LC502G	€ 169,00
MULTISTRADA 1000	03-06	LB501A	LB501B	LB501G	€ 169,00	LC501A	LC501B	LC501G	€ 169,00
MULTISTRADA 1100	2007 ▶	LB501A	LB501B	LB501G	€ 169,00	LC501A	LC501B	LC501G	€ 169,00
DUCATI ST3	2004 ▶	LB501A	LB501B	LB501G	€ 169,00	LC501A	LC501B	LC501G	€ 169,00
DUCATI ST4	04-05	LB501A	LB501B	LB501G	€ 169,00	LC501A	LC501B	LC501G	€ 169,00
SPORT CLASSIC GT1000	2006 ▶	LB501A	LB501B	LB501G	€ 169,00	LC501A	LC501B	LC501G	€ 169,00
749	03-06	LB500A	LB500B	LB500G	€ 169,00	LC500A	LC500B	LC500G	€ 169,00
999	03-06	LB500A	LB500B	LB500G	€ 169,00	LC500A	LC500B	LC500G	€ 169,00

■ ■ ■ HONDA

MODEL	YEAR	BRAKE LEVER				CLUTCH LEVER			
		NATURAL	BLACK	GOLD	PRICE	NATURAL	BLACK	GOLD	PRICE
CBR600RR	03-06	LB102A	LB102B	LB102G	€ 169,00	LC200A	LC200B	LC200G	€ 129,00
CBR1000RR	2004 ▶	LB103A	LB103B	LB103G	€ 169,00	LC101A	LC101B	LC101G	€ 169,00
HORNET 600	03-06	LB100A	LB100B	LB100G	€ 169,00	LC100A	LC100B	LC100G	€ 129,00



BRAKE/CLUTCH LEVERS

DESIGN
REGISTRATION
524939

■ ■ ■ KAWASAKI

MODEL	YEAR	BRAKE LEVER				CLUTCH LEVER			
		NATURAL	BLACK	GOLD	PRICE	NATURAL	BLACK	GOLD	PRICE
ZX-6RR	05-06	LB300A	LB300B	LB300G	€ 169,00	LC301A	LC301B	LC301G	€ 129,00
ZX-6R 636	05-06	LB300A	LB300B	LB300G	€ 169,00	LC301A	LC301B	LC301G	€ 129,00
ZX-6R	2007 ▶	LB300A	LB300B	LB300G	€ 169,00	LC301A	LC301B	LC301G	€ 129,00
ZX-10R	2006 ▶	LB301A	LB301B	LB301G	€ 169,00	LC301A	LC301B	LC301G	€ 129,00
ER-6N	2005 ▶	LB100A	LB100B	LB100G	€ 169,00	LC300A	LC300B	LC300G	€ 129,00
ER-6F	2005 ▶	LB100A	LB100B	LB100G	€ 169,00	LC300A	LC300B	LC300G	€ 129,00
Z750	04-06	LB100A	LB100B	LB100G	€ 169,00	LC300A	LC300B	LC300G	€ 129,00
Z750S	05-06	LB100A	LB100B	LB100G	€ 169,00	LC300A	LC300B	LC300G	€ 129,00
Z1000	03-06	LB100A	LB100B	LB100G	€ 169,00	LC301A	LC301B	LC301G	€ 129,00

■ ■ ■ SUZUKI

MODEL	YEAR	BRAKE LEVER				CLUTCH LEVER			
		NATURAL	BLACK	GOLD	PRICE	NATURAL	BLACK	GOLD	PRICE
GSX-R600	2006 ▶	LB400A	LB400B	LB400G	€ 169,00	LC200A	LC200B	LC200G	€ 129,00
GSX-R750	2006 ▶	LB400A	LB400B	LB400G	€ 169,00	LC200A	LC200B	LC200G	€ 129,00
GSX-R1000	05-06	LB400A	LB400B	LB400G	€ 169,00	LC200A	LC200B	LC200G	€ 129,00
GSX-R1000	2007 ▶	LB400A	LB400B	LB400G	€ 169,00	LC400A	LC400B	LC400G	€ 169,00

■ ■ ■ YAMAHA

MODEL	YEAR	BRAKE LEVER				CLUTCH LEVER			
		NATURAL	BLACK	GOLD	PRICE	NATURAL	BLACK	GOLD	PRICE
YZF-R6	2005 ▶	LB201A	LB201B	LB201G	€ 169,00	LC200A	LC200B	LC200G	€ 129,00
YZF-R1	2004 ▶	LB201A	LB201B	LB201G	€ 169,00	LC200A	LC200B	LC200G	€ 129,00
FZ6	2004 ▶	LB200A	LB200B	LB200G	€ 169,00	LC200A	LC200B	LC200G	€ 129,00
FZS1000	01-05	LB100A	LB100B	LB100G	€ 169,00	LC200A	LC200B	LC200G	€ 129,00
FZ1	2006 ▶	LB200A	LB200B	LB200G	€ 169,00	LC200A	LC200B	LC200G	€ 129,00
FZ1 FAZER	2006 ▶	LB200A	LB200B	LB200G	€ 169,00	LC200A	LC200B	LC200G	€ 129,00



RISERS

conical handlebar universal adapters ■ ■ ■

CODE	HEIGHT (H)	COLOR	PRICE (PAIR)
AZ402S	42 mm	COOL GREY	€ 79,00
AZ402B	42 mm	BLACK	€ 79,00
AZ403S	60 mm	COOL GREY	€ 79,00
AZ403B	60 mm	BLACK	€ 79,00





SCREWS INCLUDED
NR. 2 M10X60 - NR. 2 M10X80



conical handlebar adapters ■ ■ ■

BMW

MODEL	YEAR	CODE	PRICE (PAIR)
R850R - R1150 R	TUTTI	AZ405B	€ 99,00

DUCATI

MODEL	YEAR	CODE	PRICE (PAIR)
MONSTER 620/750/800/900	2001 ▶	AZ405B	€ 99,00
MONSTER 695/1000/S2R DARK	TUTTI	AZ405B	€ 99,00
MULTISTRADA 620	TUTTI	AZ405B	€ 99,00

HONDA

MODEL	YEAR	CODE	PRICE (PAIR)
CB600/900 HORNET	◀ 2006	AZ405B	€ 99,00

KAWASAKI

MODEL	YEAR	CODE	PRICE (PAIR)
ER-6N/F	TUTTI	AZ405B	€ 99,00

SUZUKI

MODEL	YEAR	CODE	PRICE (PAIR)
GSR 600	2006 ▶	AZ405B	€ 99,00

YAMAHA

MODEL	YEAR	CODE	PRICE (PAIR)
TDM 900	1996-2001	AZ405B	€ 99,00
FZ6 N	2004 ▶	AZ405B	€ 99,00



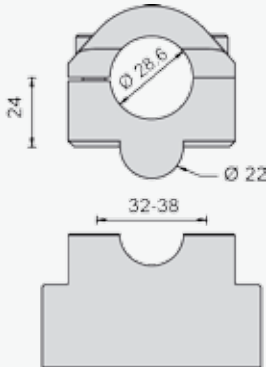



For mounting on other models, see the adjacent illustration with dimensions. The original handlebar clamp must be in one piece with the triple tree, with centres of between 32 and 38 mm.



INDICATOR LIGHTS



The LED direction indicators are amongst enthusiasts' favourite after-market items and Rizoma was one of the first producers to make them available. Our Track-01 universal indicators suggest determination and elegance while complying with the Highway Code: they are "E" approved for mounting either on the front or rear of the bike.



TRACK-01 ■■■



CODE	COLOR	PRICE (EACH)
FR013A	NATURAL	€ 29,50
FR013B	BLACK	€ 29,50



Indicator light needs resistor or flasher kit.
(SEE PAGE 45)

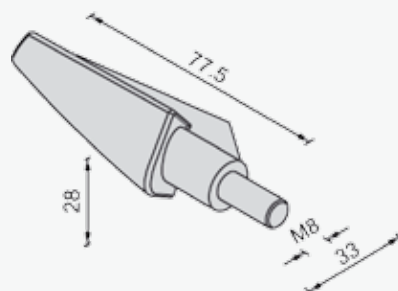

INDICATOR LIGHTS



The "Zero" indicators with LED operation are approved according to European regulations and are of a contemporary and essential design that makes them universally applicable.

■ ■ ■ ZERO

CODE	COLOR	PRICE (EACH)
FR005A	NATURAL	€ 29,50
FR005B	BLACK	€ 29,50

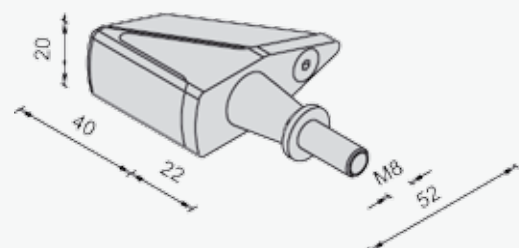

Indicator light needs resistor or flasher kit.
(SEE PAGE 45)

INDICATOR LIGHTS



indicator light ■ ■ ■

CODE	COLOR	PRICE (EACH)
FR002A	NATURAL	€ 32,00
FR002B	BLACK	€ 32,00
FR002L	POLISHED	€ 32,00

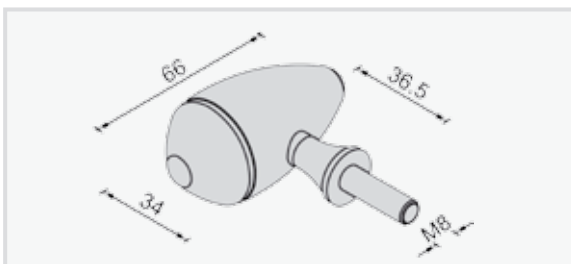

⚠ sold each



INDICATOR LIGHT ADAPTERS FOR FRONT FAIRING



The kit is formed by 4 pieces, which correspond to 2 adapters which are built in plastic.

HONDA ■ ■ ■

CODE	COLOR	MODEL	YEAR	PRICE
FR216B	BLACK	ALL	ALL	€ 9,50

KAWASAKI ■ ■ ■

CODE	COLOR	MODEL	YEAR	PRICE
FR210B	BLACK	ALL	ALL	€ 9,50

SUZUKI ■ ■ ■

CODE	COLOR	MODEL	YEAR	PRICE
FR214B	BLACK	ALL	ALL	€ 9,50

YAMAHA ■ ■ ■

CODE	COLOR	MODEL	YEAR	PRICE
FR212B	BLACK	R1	2002 ▶	€ 9,50
FR212B	BLACK	R6	2002 ▶	€ 9,50
FR212B	BLACK	FZ-6 FAZER	2004 ▶	€ 9,50
FR212B	BLACK	FZ-1 FAZER	2006 ▶	€ 9,50
FR210B	BLACK	OTHER MODELS	ALL	€ 9,50

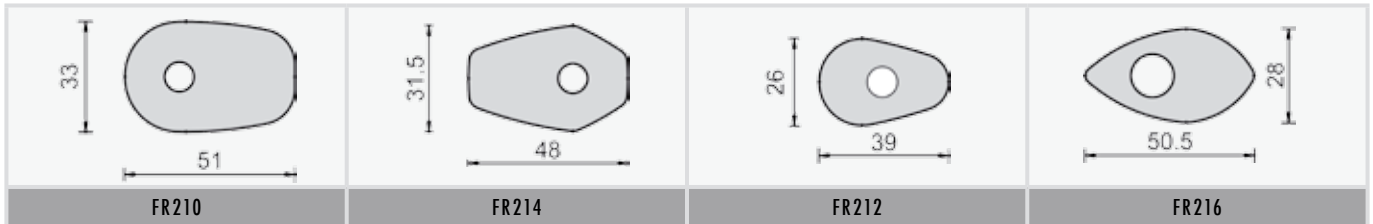

■ ■ ■ Flasher kit, to be connected to the original one

CODE	PRICE
EE030H	€ 17,50



■ ■ ■ resistor kit (pair)

CODE	PRICE
EE025H	€ 16,00



This kit is designed to be used when mounting four turn signals. Each kit includes two resistors.



■ ■ ■ indicator light spacer (32 mm)

CODE	COLOR	PRICE (EACH)
FR300A	NATURAL	€ 3,50
FR300B	BLACK	€ 3,50

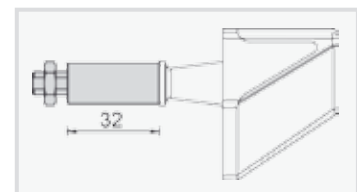

LICENSE PLATE SUPPORT LIGHTS



license plate support light ■ ■ ■

CODE	COLOR	PRICE
EE042B	BLACK	€ 36,00

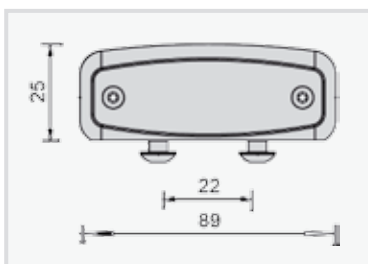

license plate support light ■ ■ ■

CODE	COLOR	PRICE
EE040A	NATURAL	€ 46,00

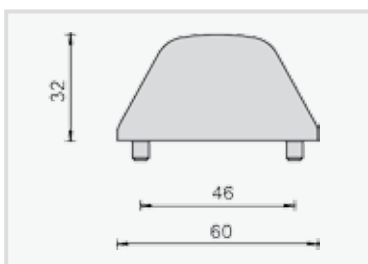

reflector kit ■ ■ ■

CODE	PRICE
EE045H	€ 12,00





LICENSE PLATE SUPPORTS

DESIGN
REGISTRATION
524939

Rizoma has always specialised in the creation of universal number plate supports and, for 2007, it is offering superlight versions complete with approved number plate light, indicator mounting adaptor and reflector kits. There is an exclusive option to alter the angle required by the Highway Code, to be employed only when using the bike on the track.



OUR LICENSE PLATE SUPPORT KIT INCLUDES:
LICENSE PLATE SUPPORT
LICENSE PLATE SUPPORT LIGHT
INDICATOR LIGHT SUPPORTS
REFLECTOR KIT

■ ■ ■ BUELL (Mountable on our tail unit ZZB013C - page 67)

MODEL	YEAR	157x157 mm	175x130 mm	146x69.5 mm	PRICE
XB9S	2003 ▶	PT200B1	PT200B2	PT200B3	€ 99,00
XB9SX	2004 ▶	PT200B1	PT200B2	PT200B3	€ 99,00
XB12S	2003 ▶	PT200B1	PT200B2	PT200B3	€ 99,00
XB12SS	2005 ▶	PT200B1	PT200B2	PT200B3	€ 99,00

■ ■ ■ DUCATI

MODEL	YEAR	157x157 mm	175x130 mm	146x69.5 mm	PRICE
MONSTER	1997 ▶	PT500B1	PT500B2	PT500B3	€ 99,00
MULTISTRADA 620	2004 ▶	PT501B1	PT501B2	PT501B3	€ 99,00
MULTISTRADA 1000	2003 ▶	PT501B1	PT501B2	PT501B3	€ 99,00
MULTISTRADA 1100	2007 ▶	PT501B1	PT501B2	PT501B3	€ 99,00
749/749S	03-06	PT502B1	PT502B2	PT502B3	€ 99,00
999/999S	03-06	PT502B1	PT502B2	PT502B3	€ 99,00

■ ■ ■ HONDA

MODEL	YEAR	157x157 mm	175x130 mm	146x69.5 mm	PRICE
CBR600RR	03-06	PT100B1	PT100B2	PT100B3	€ 99,00
CBR600RR	2007 ▶	PT101B1	PT101B2	PT101B3	€ 199,00
CBR1000RR	2004 ▶	PT100B1	PT100B2	PT100B3	€ 99,00

■ ■ ■ KAWASAKI

MODEL	YEAR	157x157 mm	175x130 mm	146x69.5 mm	PRICE
Z750	04-06	PT300B1	PT300B2	PT300B3	€ 99,00
Z750	2007 ▶	PT306B1	PT306B2	PT306B3	€ 99,00
Z1000	03-06	PT300B1	PT300B2	PT300B3	€ 99,00
Z1000	2007 ▶	PT306B1	PT306B2	PT306B3	€ 99,00
ER-6N	2005 ▶	PT301B1	PT301B2	PT301B3	€ 99,00
ZX-6 RR	03-04	PT300B1	PT300B2	PT300B3	€ 99,00
ZX-6 RR	05-06	PT302B1	PT302B2	PT302B3	€ 99,00
ZX-10RR	04-05	PT301B1	PT301B2	PT301B3	€ 99,00
ZX-10RR	2006 ▶	PT304B1	PT304B2	PT304B3	€ 99,00

■ ■ ■ KTM

MODEL	YEAR	157x157 mm	175x130 mm	146x69.5 mm	PRICE
990 SUPER DUKE	2005 ▶	PT675B1	PT675B2	PT675B3	€ 99,00

■ ■ ■ MV AGUSTA

MODEL	YEAR	157x157 mm	175x130 mm	146x69.5 mm	PRICE
BRUTALE 750	2002 ▶	PT600B1	PT600B2	PT600B3	€ 99,00
BRUTALE 910	2005 ▶	PT600B1	PT600B2	PT600B3	€ 99,00

■ ■ ■ SUZUKI

MODEL	YEAR	157x157 mm	175x130 mm	146x69.5 mm	PRICE
GSX-R 600	04-05	PT401B1	PT401B2	PT401B3	€ 99,00
GSX-R 600	2006 ▶	PT403B1	PT403B2	PT403B3	€ 99,00
GSX-R 750	04-05	PT401B1	PT401B2	PT401B3	€ 99,00
GSX-R 750	2006 ▶	PT403B1	PT403B2	PT403B3	€ 99,00
GSX-R 1000	03-04	PT400B1	PT400B2	PT400B3	€ 99,00
GSX-R 1000	2005 ▶	PT402B1	PT402B2	PT402B3	€ 99,00
GSR 600	2006 ▶	PT404B1	PT404B2	PT404B3	€ 99,00

■ ■ ■ TRIUMPH

MODEL	YEAR	157x157 mm	175x130 mm	146x69.5 mm	PRICE
SPEED TRIPLE	2005 ▶	PT650B1	PT650B2	PT650B3	€ 99,00

■ ■ ■ YAMAHA

MODEL	YEAR	157x157 mm	175x130 mm	146x69.5 mm	PRICE
YZF-R6	02-05	PT200B1	PT200B2	PT200B3	€ 99,00
YZF-R6	2006 ▶	PT204B1	PT204B2	PT204B3	€ 99,00
YZF-R1	02-03	PT200B1	PT200B2	PT200B3	€ 99,00
YZF-R1	04-06	PT201B1	PT201B2	PT201B3	€ 99,00
YZF-R1	2007 ▶	PT207B1	PT207B2	PT207B3	€ 99,00
FZ1	2006 ▶	PT205B1	PT205B2	PT205B3	€ 99,00
FZ1 FAZER	2006 ▶	PT206B1	PT206B2	PT206B3	€ 99,00
FZ6 FAZER	2004 ▶	PT202B1	PT202B2	PT202B3	€ 99,00
MT03	2006 ▶	PT203B1	PT203B2	PT203B3	€ 199,00

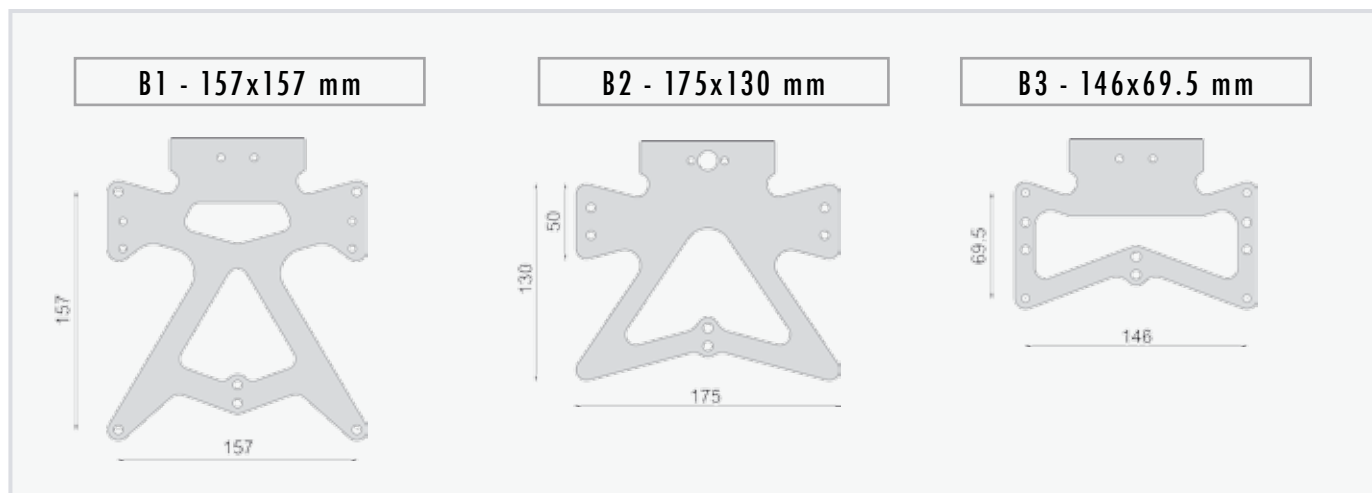

UNIVERSAL LICENSE PLATE SUPPORT

license plate support ■ ■ ■

157x157 mm	175x130 mm	146x69.5 mm	PRICE
PT001B1			€ 79,00



OUR LICENSE PLATE SUPPORT KIT INCLUDES:
 LICENSE PLATE SUPPORT
 INDICATOR LIGHT SUPPORTS
 REFLECTOR KIT

tiltable license plate support ■ ■ ■

157x157 mm	175x130 mm	146x69.5 mm	PRICE
PT010B1	PT010B2	PT010B3	€ 99,00



OUR LICENSE PLATE SUPPORT KIT INCLUDES:
 LICENSE PLATE SUPPORT
 LICENSE PLATE SUPPORT LIGHT
 INDICATOR LIGHT SUPPORTS
 REFLECTOR KIT

B1 - 157x157 mm

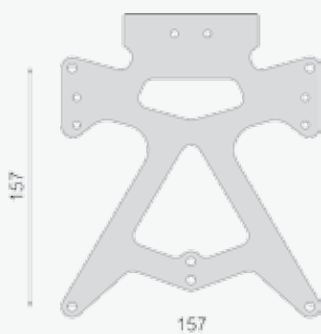

B2 - 175x130 mm

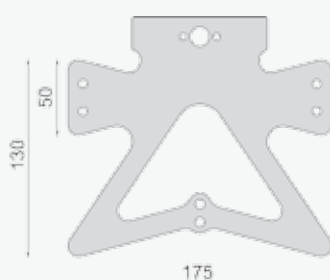

B3 - 146x69.5 mm

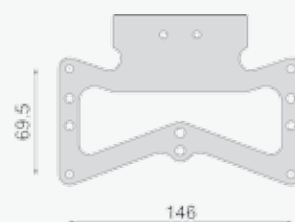



U
N
I
V
E
R
S
A
L

UNIVERSAL

REAR SET CONTROLS



Fabricated from only the finest billet aluminum alloy we achieved maximum strength, expression and nimbleness.

By anodizing the pieces different colors accentuates the final finished product. Assembled using only the finest bearings, the rider has total adjustability and reliability.

As with our other rearsets, you have the option to add passenger pegs if needed. Having a TÜV approval is your assurance of quality and safety.



REAR SET CONTROLS



■ ■ ■ BUELL

MODEL	YEAR	CODE	COLOR	PRICE
XB9R/XB12R	2003 ▶	PE258B	BLACK	€ 499,00
XB9SX	2004 ▶	PE258B	BLACK	€ 499,00
XB12R/S	2003 ▶	PE258B	BLACK	€ 499,00
XB12SS	2005 ▶	PE258B	BLACK	€ 499,00

■ ■ ■ DUCATI

MODEL	YEAR	CODE	COLOR	PRICE
916/996/998/748	ALL	PE205B	BLACK	€ 429,00
999/999S	2002 ▶	PE205B	BLACK	€ 429,00
749/749S	2003 ▶	PE205B	BLACK	€ 429,00
MONSTER S4R/S4RS	2003 ▶	PE202B	BLACK	€ 429,00
MONSTER S2R	2004 ▶	PE202B	BLACK	€ 429,00
MONSTER	2000 ▶	PE201B	BLACK	€ 499,00

■ ■ ■ HONDA

MODEL	YEAR	CODE	COLOR	PRICE
CBR600RR	2003-2006	PE067B	BLACK	€ 429,00
CBR1000RR	2004-2005	PE068B	BLACK	€ 429,00
CBR1000RR	2006 ▶	PE070B	BLACK	€ 429,00
HORNET CB 600	◀ 2006	PE062B	BLACK	€ 429,00
HORNET CB 900	TUTTI	PE062B	BLACK	€ 429,00

■ ■ ■ KAWASAKI

MODEL	YEAR	CODE	COLOR	PRICE
ZX-6R	2003-2004	PE302B	BLACK	€ 429,00
ZX-6R	2005-2006	PE310B	BLACK	€ 429,00
ZX-10R	2004-2005	PE305B	BLACK	€ 429,00
ZX-10R	2006 ▶	PE306B	BLACK	€ 429,00
ER-6	2005 ▶	PE312B	BLACK	€ 429,00
Z750	2004-2006	PE301B	BLACK	€ 429,00
Z1000	2003-2006	PE300B	BLACK	€ 429,00

■ ■ ■ KTM

MODEL	YEAR	CODE	COLOR	PRICE
990 SUPER DUKE	2005 ▶	PE470B	BLACK	€ 429,00

■ ■ ■ MV AGUSTA

MODEL	YEAR	CODE	COLOR	PRICE
F4	2000 ▶	PE430B	BLACK	€ 429,00
BRUTALE 750	2002 ▶	PE430B	BLACK	€ 429,00
BRUTALE 910	2005 ▶	PE430B	BLACK	€ 429,00

■ ■ ■ SUZUKI

MODEL	YEAR	CODE	COLOR	PRICE
GSX R 600	2001-2005	PE158B	BLACK	€ 429,00
GSX R 600	2006 ▶	PE165B	BLACK	€ 429,00
GSX R 750	2001-2005	PE158B	BLACK	€ 429,00
GSX R 750	2006 ▶	PE165B	BLACK	€ 429,00
GSX R 1000	2001-2004	PE158B	BLACK	€ 429,00
GSX R 1000	2005-2006	PE159B	BLACK	€ 429,00
GSR 600	2006 ▶	PE164B	BLACK	€ 429,00

■ ■ ■ TRIUMPH

MODEL	YEAR	CODE	COLOR	PRICE
SPEED TRIPLE	2000 ▶	PE450B	BLACK	€ 429,00

■ ■ ■ YAMAHA

MODEL	YEAR	CODE	COLOR	PRICE
R6	2003-2005	PE120B	BLACK	€ 429,00
R6	2006 ▶	PE123B	BLACK	€ 429,00
R1	1998-2003	PE110B	BLACK	€ 429,00
R1	2004-2006	PE111B	BLACK	€ 429,00
FAZER FZ6	2004 ▶	PE108B	BLACK	€ 429,00
FAZER FZ1000	2002-2005	PE109B	BLACK	€ 429,00
FZ1	2006 ▶	PE112A	NAT.	€ 429,00
FZ1 FAZER	2006 ▶	PE112A	NAT.	€ 429,00

U
N
I
V
E
R
S
A
L

PEGS

racing pegs kit (pair) ■ ■ ■

CODE	COLOR	PRICE (PAIR)
PE616A	NATURAL	€ 39,00
PE616B	BLACK	€ 39,00



■ ■ ■ spare part for PE616 (pair)

CODE	COLOR	PRICE (PAIR)
MA508B	BLACK	€ 11,50

folding pegs kit for Rizoma controls (pair) ■ ■ ■

CODE	COLOR	PRICE (PAIR)
PE608A	NATURAL	€ 59,00



folding pegs kit (pair) ■ ■ ■

CODE	COLOR	PRICE (PAIR)
PE609A	NATURAL	€ 59,00





peg for Rizoma rear set control kits (sold each)

CODE	COLOR	PRICE (PAIR)
PE612A	NATURAL	€ 31,50

gear/brake peg (sold each)

CODE	COLOR	PRICE (EACH)
PE624A	NATURAL	€ 25,00



heel guard (pair)

CODE	COLOR	PRICE (PAIR)
TT002	SILVER CARBON FIBER	€ 24,00

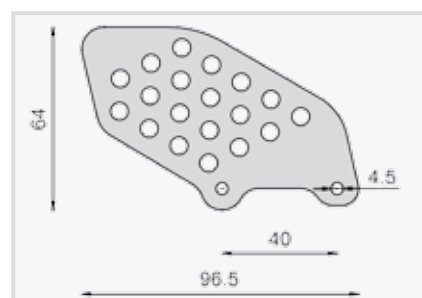

heel guard (pair)

CODE	COLOR	PRICE (PAIR)
TT003	CARBON FIBER	€ 24,00

RIDER / PASSENGER PEGS FOR ORIGINAL CONTROLS

rider/passenger peg kit ■ ■ ■

CODE	COLOR	PRICE
PE614A	NATURAL	€ 39,00
PE614B	BLACK	€ 39,00
PE614G	GOLD	€ 39,00
PE614R	RED	€ 39,00
PE614U	BLUE	€ 39,00



ADAPTERS FOR ART. PE614

CODE	COLOR	PRICE
SEE TABLES	NATURAL	€ 22,00



These pegs can be installed on various models with the adapters indicated



BUELL

MODEL	YEAR	CODE	
		RIDER	PASSENGER
X1	ALL	PE730A	PE730A

DUCATI

MODEL	YEAR	CODE	
		RIDER	PASSENGER
M600/750/800/900/1000	ALL		PE710A

HONDA

MODEL	YEAR	CODE	
		RIDER	PASSENGER
CBR600F	1999 ▶	PE650A	
CBR600FS	2001-2002	PE650A	
CBR600RR	2003-2006	PE650A	
CBR900	◀ 2003	PE650A	
CB600/900 HORNET	ALL	PE650A	PE651A
CBR1000RR	2006 ▶	PE652A	

KAWASAKI

MODEL	YEAR	CODE	
		RIDER	PASSENGER
Z750	2004-2006	PE750A	
Z1000	2003-2006	PE750A	PE752A
ZX-10R	2006 ▶		PE752A

SUZUKI

MODEL	YEAR	CODE	
		RIDER	PASSENGER
GSX-R 600/750/1000	◀ 2004	PE690A	PE691A
SV650/1000	ALL	PE690A	PE691A
GSF 600/S	ALL	PE690A	PE690A
GSF 1200/S	ALL	PE690A	PE690A

YAMAHA

MODEL	YEAR	CODE	
		RIDER	PASSENGER
R1	2002-2003	PE672A	PE674A
R6	2003-2004	PE672A	PE674A
FZ1	2006 ▶		PE676A
FZ1 FAZER	2006 ▶		PE676A

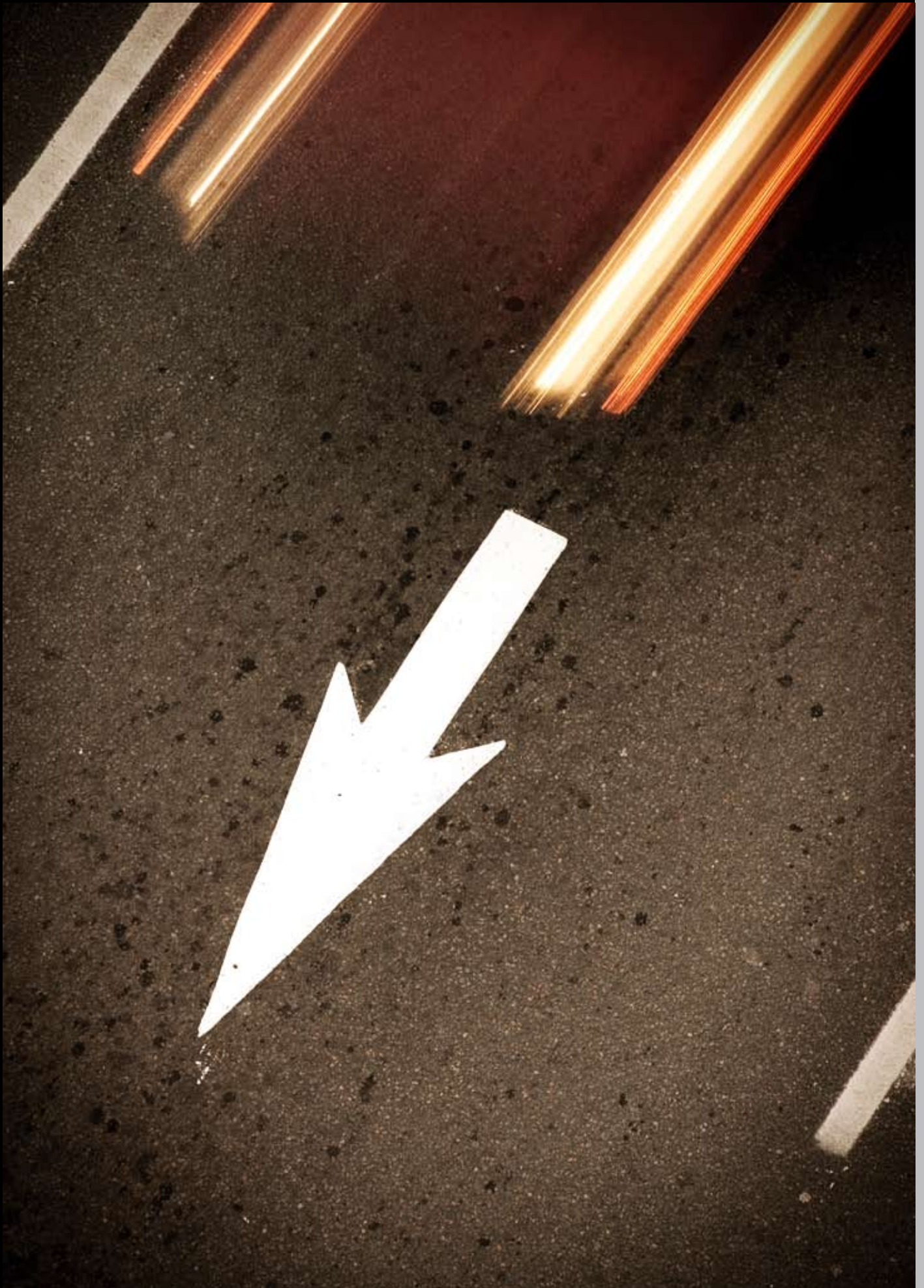

ENGINE / FAIRING GUARDS



Essential and indispensable fairing and engine guards. They limit the damage to the engine, fairings and frame in the event of a fall. The part made of "Teflon®" combined with aluminium cushions the impact, protecting the engine from undesirable consequences.



ENGINE / FAIRING GUARDS

■ ■ ■ HONDA

MODEL	YEAR	CODE	COLOR	PRICE (PAIR)
CBR600 RR	2003-2006	PM108B	BLACK	€ 59,00
CBR1000 RR	2004-2005	PM110B	BLACK	€ 72,00
CBR1000 RR	2006 ▶	PM112B	BLACK	€ 72,00
CB600 HORNET	◀ 2006	PM100B	BLACK	€ 59,00
CB900 HORNET	ALL	PM103B	BLACK	€ 59,00

SPARE PARTS:
PM020B IMPACT ABSORBENT PAD
BLACK (PAIR): € 19,00

■ ■ ■ KAWASAKI

MODEL	YEAR	CODE	COLOR	PRICE (PAIR)
ZX-6R 636	◀ 2002	PM301B	BLACK	€ 59,00
ZX-6R 636	2003-2004	PM303B	BLACK	€ 59,00
ZX-9R	◀ 2003	PM301B	BLACK	€ 59,00
ZX-10RR	2004-2005	PM307B	BLACK	€ 158,00
ZX-10RR	2006 ▶	PM309B	BLACK	€ 158,00
ER-6N	2006 ▶	PM308B	BLACK	€ 59,00
Z750/Z750S	2004-2006	PM304B	BLACK	€ 59,00
Z1000	2003-2006	PM305B	BLACK	€ 69,00

■ ■ ■ MV AGUSTA

MODEL	YEAR	CODE	COLOR	PRICE (PAIR)
BRUTALE 750	2002 ▶	PM430B	BLACK	€ 59,00
BRUTALE 910	2005 ▶	PM430B	BLACK	€ 59,00

■ ■ ■ SUZUKI

MODEL	YEAR	CODE	COLOR	PRICE (PAIR)
GSX-R600/750	2004-2005	PM159B	BLACK	€ 59,00
GSX-R600/750	2006 ▶	PM162B	BLACK	€ 159,00
GSX-R1000	2003-2004	PM159B	BLACK	€ 59,00
GSX-R1000	2005-2006	PM160B	BLACK	€ 59,00
SV650/SV650S	2003 ▶	PM151B	BLACK	€ 59,00
SV1000/SV1000S	2003 ▶	PM151B	BLACK	€ 59,00
BANDIT 600	◀ 2004	PM153B	BLACK	€ 78,00
BANDIT 1200	◀ 2005	PM153B	BLACK	€ 78,00
GSR 600	2006 ▶	PM202B	BLACK	€ 59,00

■ ■ ■ TRIUMPH

MODEL	YEAR	CODE	COLOR	PRICE (PAIR)
SPEED TRIPLE	ALL	PM250B	BLACK	€ 78,00

■ ■ ■ YAMAHA

MODEL	YEAR	CODE	COLOR	PRICE (PAIR)
YZF-R6	◀ 2004	PM205B	BLACK	€ 59,00
YZF-R6	2006 ▶	PM207B	BLACK	€ 59,00
YZF-R1	◀ 2003	PM205B	BLACK	€ 59,00
YZF-R1	2004-2006	PM206B	BLACK	€ 59,00
FAZER 600	◀ 2003	PM203B	BLACK	€ 59,00
FAZER FZ6	2004 ▶	PM202B	BLACK	€ 59,00
FAZER1000	◀ 2005	PM203B	BLACK	€ 59,00
FZ1	2006 ▶	PM208B	BLACK	€ 59,00
FZ1 FAZER	2006 ▶	PM208B	BLACK	€ 59,00

SPORT

So many models from the best marques
made unique by our accessories,
which combine the racing image and elegance,
attention to technical details and essential look.



BMW® r1200s

RIZOMA ACCESSORIES FOR BMW MODELS ARE EXCLUSIVE DISTRIBUTED BY OUR DISTRIBUTION-PARTNER THE WUNDERLICH GMBH (WORLDWIDE).
Tel.: +49 (0)2642 97980 or via email info@wunderlich.de
www.wunderlich.de



bmw® k1200r

S
P
O
R
T



b
m
w®





■ ■ ■ rear set control kit

Fabricated from only the finest billet aluminum alloy we achieved maximum strength, expression and nimbleness. By anodizing the pieces different colors accentuates the final finished product. Assembled using only the finest bearings, the rider has total adjustability and reliability. As with our other rearsets, you have the option to add passenger pegs if needed. Having a TÜV approval is your assurance of quality and safety.

MODEL	YEAR	CODE	COLOR	PRICE
XB9R/XB12R	2003 ▶	PE258B	BLACK	€ 499,00
XB9SX	2004 ▶	PE258B	BLACK	€ 499,00
XB12R/S	2003 ▶	PE258B	BLACK	€ 499,00
XB12SS	2005 ▶	PE258B	BLACK	€ 499,00
XB12STT	2007 ▶	PE258B	BLACK	€ 499,00

■ ■ ■ handlebar clamp

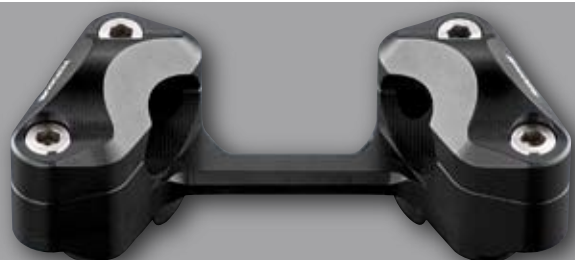

MODEL	YEAR	CODE	COLOR	PRICE
XB9SX	2004 ▶	AZ600B	BLACK	€ 189,00
XB12S	2003 ▶	AZ600B	BLACK	€ 189,00
XB12SS	2005 ▶	AZ600B	BLACK	€ 189,00
XB12X	2006 ▶	AZ600B	BLACK	€ 189,00
XB12STT	2007 ▶	AZ600B	BLACK	€ 189,00

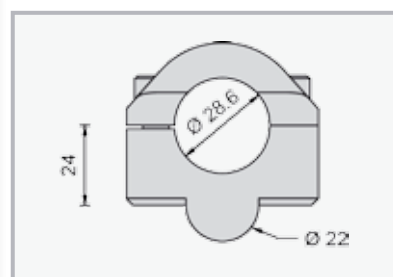

DESIGN
REGISTRATION
524939

front pulley cover ■ ■ ■

MODEL	YEAR	CODE	COLOR	PRICE
XB9R/XB12R	2003 ▶	ZZB020A	NATURAL	€ 237,00
XB9SX	2004 ▶	ZZB020A	NATURAL	€ 237,00
XB12R/S	2003 ▶	ZZB020A	NATURAL	€ 237,00
XB12SS	2005 ▶	ZZB020A	NATURAL	€ 237,00
XB12X	2006 ▶	ZZB020A	NATURAL	€ 237,00
XB12SST	2007 ▶	ZZB020A	NATURAL	€ 237,00



pulley 65 teeth ■ ■ ■

MODEL	YEAR	CODE	COLOR	PRICE
XB9R/XB12R	2003 ▶	ZZB010B	BLACK	€ 329,00
XB9SX	2004 ▶	ZZB010B	BLACK	€ 329,00
XB12R/S	2003 ▶	ZZB010B	BLACK	€ 329,00
XB12SS	2005 ▶	ZZB010B	BLACK	€ 329,00
XB12X	2006 ▶	ZZB010B	BLACK	€ 329,00
XB12SST	2007 ▶	ZZB010B	BLACK	€ 329,00



belt cover ■ ■ ■

MODEL	YEAR	CODE	COLOR	PRICE
XB9R/XB12R	2003-2005	ZZB015A	NATURAL	€ 79,00
XB9SX	2004-2005	ZZB015A	NATURAL	€ 79,00
XB12R/S	2003-2005	ZZB015A	NATURAL	€ 79,00





■ ■ ■ rear part

MODEL	YEAR	CODE	COLOR	PRICE
XB9SX	2004 ▶	ZZB013C	SILVER MAT	€ 129,00
XB12S	2003 ▶	ZZB013C	SILVER MAT	€ 129,00
XB12SS	2005 ▶	ZZB013C	SILVER MAT	€ 129,00



■ ■ ■ license plate support
(Mountable on our tail unit ZZB013C)

MODEL	YEAR	mm 157x157	mm 175x130	mm 146x69.5	PRICE
XB9S	2003 ▶	PT200B1	PT200B2	PT200B3	€ 99,00
XB9SX	2004 ▶	PT200B1	PT200B2	PT200B3	€ 99,00
XB12S	2003 ▶	PT200B1	PT200B2	PT200B3	€ 99,00
XB12SS	2005 ▶	PT200B1	PT200B2	PT200B3	€ 99,00

buell® x1



■ ■ ■ pulley 61 teeth

MODEL	YEAR	CODE	COLOR	PRICE
M1/X1	◀ 2002	ZZH012L	POLISHED	€ 389,00

ducati® supersport





Our rearsets are designed to handle any riding condition, designed with total adjustability, no ALU-MATTER the driver's size or type of riding. Our rearsets are designed to compensate for 16.5" tires, when even a little adjustability can be a big advantage on the track. Fabricated from only the finest billet aluminum alloy we achieved maximum strength and rigidity. To please the rider the pegs are concentric and can easily be adjusted to any position. Our rearsets are built with only the finest bearings. Which guarantee the rider precision and ease of use.

■ ■ ■ rear set control kit

MODEL	YEAR	CODE	COLOR	PRICE
748	ALL	PE205B	BLACK	€ 429,00
749/749S/749R	ALL	PE205B	BLACK	€ 429,00
916	ALL	PE205B	BLACK	€ 429,00
996/998	ALL	PE205B	BLACK	€ 429,00
999/999S/999R	ALL	PE205B	BLACK	€ 429,00

■ ■ ■ reversed gearchange lever



MODEL	YEAR	CODE	COLOR	PRICE
748	ALL	PE206B	BLACK	€ 69,00
749/749S/749R	ALL	PE206B	BLACK	€ 69,00
916	ALL	PE206B	BLACK	€ 69,00
996/998	ALL	PE206B	BLACK	€ 69,00
999/999S/999R	ALL	PE206B	BLACK	€ 69,00

timing belt cover ■ ■ ■



MODEL	YEAR	CODE	COLOR	PRICE
999	◀ 2004	ZDM065S	COOL GREY	€ 149,00
999S	◀ 2004	ZDM065S	COOL GREY	€ 149,00
749	◀ 2004	ZDM065S	COOL GREY	€ 149,00
749S	◀ 2004	ZDM065S	COOL GREY	€ 149,00

lexan® spare part	ZDM065-02	
-------------------	-----------	--

license plate support ■ ■ ■



MODEL	YEAR	mm 157x157	mm 175x130	mm 146x69.5	PRICE
749/749S	2003 ▶	PT502B1	PT502B2	PT502B3	€ 99,00
999/999S	2002 ▶	PT502B1	PT502B2	PT502B3	€ 99,00

MORE ACCESSORIES, SEE PAGES 68-69



ducati® monster





Created for those who desire race-worthy control, with an aggressive aspect, the geometry is calculated to obtain a radical setting without forgetting the constructive philosophy of the motorcycle. Each one of our components is engineered using to our advantage the properties of the specific aluminum alloy, in this case the high strength 6082T6, color anodized for exactly the right look.



■ ■ ■ upper triple tree with clip-on bars kit



MODEL	YEAR	CODE	COLOR	PRICE
620	ALL	PA202D		€ 329,00
750	2002	PA202D		€ 329,00
800	ALL	PA202D		€ 329,00
900	2002	PA202D		€ 329,00
1000	ALL	PA202D		€ 329,00
S2R/S4R/S4	ALL	PA202D		€ 329,00



■ ■ ■ engine guard

MODEL	YEAR	CODE	COLOR	PRICE (PAIR)
ALL	2001 ▶	PM350B	BLACK	€ 122,00



■ ■ ■ license plate support

MODEL	YEAR	mm 157x157	mm 175x130	mm 146x69.5	PRICE
MONSTER	1997 ▶	PT500B1	PT500B2	PT500B3	€ 99,00

rear set control kit ■ ■ ■

MODEL	YEAR	CODE	COLOR	PRICE
S2R	2004 ▶	PE202B	BLACK	€ 429,00
S4R	2003 ▶	PE202B	BLACK	€ 429,00

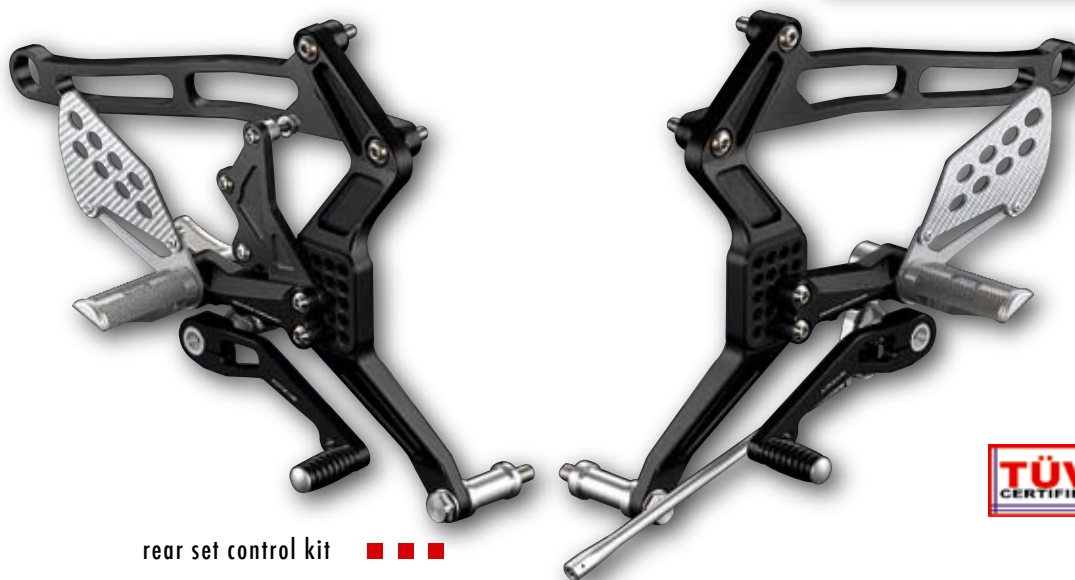

rear set control kit ■ ■ ■

MODEL	YEAR	CODE	COLOR	PRICE
600	2000 ▶	PE201B	BLACK	€ 499,00
620	2000 ▶	PE201B	BLACK	€ 499,00
750	2000 ▶	PE201B	BLACK	€ 499,00
800	2000 ▶	PE201B	BLACK	€ 499,00
900	2000 ▶	PE201B	BLACK	€ 499,00
1000	2000 ▶	PE201B	BLACK	€ 499,00
S4	'01-'03	PE201B	BLACK	€ 499,00



ADAPTER CODE PE569B IS REQUIRED FOR MOUNTING HIGH POSITION MUFFLERS

passenger pegs kit for Rizoma rear set controls ■ ■ ■

MODEL	YEAR	CODE	COLOR	PRICE
ALL	ALL	PE568B	BLACK	€ 149,00

EXCEPT S2R/S4R MODELS





■ ■ ■ timing belt cover

MODEL	YEAR	CODE	COLOR	PRICE
1000	2002 ▶	ZDM019A	NATURAL	€ 289,00
1000	2002 ▶	ZDM019B	BLACK	€ 289,00
S2R 1000	2005 ▶	ZDM019A	NATURAL	€ 289,00
S2R 1000	2005 ▶	ZDM019B	BLACK	€ 289,00
lexan® spare part		ZDM019-034		€ 25,00



■ ■ ■ timing belt cover

MODEL	YEAR	CODE	COLOR	PRICE
S4	2001-2003	ZDM050A	NATURAL	€ 369,00
S4R	2003-2006	ZDM050A	NATURAL	€ 369,00
lexan® spare part		ZDM019-0345		€ 25,00



■ ■ ■ timing belt cover

MODEL	YEAR	CODE	COLOR	PRICE
600 / 620	ALL	ZDM016A	NATURAL	€ 289,00
600 / 620	ALL	ZDM016B	BLACK	€ 289,00
750 / 800	ALL	ZDM016A	NATURAL	€ 289,00
750 / 800	ALL	ZDM016B	BLACK	€ 289,00
S2R	ALL	ZDM016A	NATURAL	€ 289,00
S2R	ALL	ZDM016B	BLACK	€ 289,00
lexan® spare part		ZDM016-0345		€ 25,00



■ ■ ■ heat shield

MODEL	YEAR	CODE	COLOR	PRICE
S2R	2004 ▶	ZDM080B	NATURAL	€ 99,00
S4R	2003 ▶	ZDM080B	NATURAL	€ 99,00

MORE ACCESSORIES, SEE PAGES 78-79

ducati® multistrada





■ ■ ■ fluid tank cover (pair)

MODEL	YEAR	CODE	COLOR	PRICE (PAIR)
1000	ALL	CT320R	RED	€ 79,00



■ ■ ■ timing belt cover

MODEL	YEAR	CODE	COLOR	PRICE
1000	ALL	ZDM019A	NATURAL	€ 289,00
1000	ALL	ZDM019B	BLACK	€ 289,00

lexan® spare part	ZDM019-034	€ 25,00
-------------------	------------	---------



■ ■ ■ timing belt cover

MODEL	YEAR	CODE	COLOR	PRICE
620	ALL	ZDM016A	NATURAL	€ 249,00
620	ALL	ZDM016B	BLACK	€ 249,00

lexan® spare part	ZDM016-0345	€ 25,00
-------------------	-------------	---------

■ ■ ■ license plate support

MODEL	YEAR	mm 157x157	mm 175x130	mm 146x69.5	PRICE
MULTISTRADA 620	2004 ▶	PT501B1	PT501B2	PT501B3	€ 99,00
MULTISTRADA 1000	03-06	PT501B1	PT501B2	PT501B3	€ 99,00
MULTISTRADA 1100	2007 ▶	PT501B1	PT501B2	PT501B3	€ 99,00



MORE ACCESSORIES, SEE PAGES 78-79



The many versions and colors of our Clutch Cover and Pressure Plates can be installed on any dry clutch Ducati motorcycle. Models excluded are the 600, 620, 750, and 800.

clutch cover ■ ■ ■

CODE	COLOR	PRICE
ZDM024A	NATURAL	€ 126,00
ZDM024B	BLACK	€ 126,00
ZDM024G	GOLD	€ 126,00
ZDM024R	RED	€ 126,00



clutch cover ■ ■ ■

CODE	COLOR	PRICE
ZDM025A	NATURAL	€ 126,00
ZDM025G	GOLD	€ 126,00

lexan® spare part	ZDM025-02	€ 11,00
-------------------	-----------	---------



clutch cover ■ ■ ■

CODE	COLOR	PRICE
ZDM023A	NATURAL	€ 126,00
ZDM023B	BLACK	€ 126,00
ZDM023G	GOLD	€ 126,00

lexan® spare part	ZDM023-02	€ 11,00
-------------------	-----------	---------



pressure plate ■ ■ ■

CODE	COLOR	PRICE
ZDM035A	NATURAL	€ 123,00
ZDM035B	BLACK	€ 123,00
ZDM035G	GOLD	€ 123,00
ZDM035R	RED	€ 123,00





■ ■ ■ sprocket cover

CODE	COLOR	PRICE
ZDM015A	NATURAL	€ 69,00



■ ■ ■ sprocket cover

CODE	COLOR	PRICE
ZDM014A	NATURAL	€ 99,00
ZDM014B	BLACK	€ 99,00



■ ■ ■ oil fill plug

CODE	COLOR	PRICE
ZDM070A	NATURAL	€ 22,00
ZDM070B	BLACK	€ 22,00
ZDM070G	GOLD	€ 22,00
ZDM070R	RED	€ 22,00

HONDA

honda® cbr 1000RR





■ ■ ■ rear set control kit

MODEL	YEAR	CODE	COLOR	PRICE
CBR1000 RR	2004-2005	PE068B	BLACK	€ 429,00
CBR1000 RR	2006 ▶	PE070B	BLACK	€ 429,00



■ ■ ■ fairing guard

MODEL	YEAR	CODE	COLOR	PRICE (PAIR)
CBR1000 RR	'04-'05	PM110B	BLACK	€ 59,00
CBR1000 RR	2006 ▶	PM112B	BLACK	€ 59,00



■ ■ ■ license plate support

MODEL	YEAR	157x157 mm	175x130 mm	146x69.5 mm	PRICE
CBR1000 RR	2004 ▶	PT100B1	PT100B2	PT100B3	€ 99,00

HONDA

honda® cbr 600





■ ■ ■ rear set control kit

MODEL	YEAR	CODE	COLOR	PRICE
CBR600FS	2001-2002	PE065B	BLACK	€ 429,00
CBR600RR	2003-2006	PE067B	BLACK	€ 429,00



■ ■ ■ fairing guard



MODEL	YEAR	CODE	COLOR	PRICE (PAIR)
CBR600 RR	2003-2006	PM108B	BLACK	€ 59,00



■ ■ ■ mirror hole caps

MODEL	YEAR	CODE	COLOR	PRICE (PAIR)
CBR600 F	1999 ▶	BS507B	BLACK	€ 24,00
CBR600 FS	'01-'02	BS507B	BLACK	€ 24,00
CBR600 RR	2003 ▶	BS507B	BLACK	€ 24,00



■ ■ ■ license plate support

MODEL	YEAR	157x157 mm	175x130 mm	146x69.5 mm	PRICE
CBR600RR	2003-2006	PT100B1	PT100B2	PT100B3	€ 99,00

HONDA[®] hornet / cb





honda® hornet / cb



rear set control kit ■ ■ ■

MODEL	YEAR	CODE	COLOR	PRICE
600	◀ 2006	PE062B	BLACK	€ 429,00
900	ALL	PE062B	BLACK	€ 429,00

passenger pegs kit ■ ■ ■

MODEL	YEAR	CODE	COLOR	PRICE
600	◀ 2006	PE565B	BLACK	€ 149,00
900	ALL	PE565B	BLACK	€ 149,00



handlebar watch kit ■ ■ ■

MODEL	YEAR	CODE	COLOR	PRICE
600	◀ 2006	CL201A	NATURAL	€ 99,00



conical handlebar adapter ■ ■ ■

MODEL	YEAR	CODE	COLOR	PRICE (PAIR)
ALL	◀ 2006	AZ405B	BLACK	€ 99,00





■ ■ ■ chain guard

MODEL	YEAR	CODE	COLOR	PRICE
600	◀ 2006	ZHH040A	NATURAL	€ 69,00



■ ■ ■ hole caps

MODEL	YEAR	CODE	COLOR	PRICE (PAIR)
600	2003-2006	ZHH032A	NATURAL	€ 29,00
900	ALL	ZHH030A	NATURAL	€ 29,00



■ ■ ■ engine guard (pair)

MODEL	YEAR	CODE	COLOR	PRICE (PAIR)
600	◀ 2006	PM100B	BLACK	€ 59,00
900	ALL	PM103B	BLACK	€ 59,00



kawasaki® ninja zx-10r





■ ■ ■ rear set control kit

MODEL	YEAR	CODE	COLOR	PRICE
ZX-10R	2004-2005	PE305B	BLACK	€ 429,00
ZX-10R	2006 ▶	PE306B	BLACK	€ 429,00



■ ■ ■ fairing guard

MODEL	YEAR	CODE	COLOR	PRICE
ZX-10R	'04-'05	PM307B	BLACK	€ 158,00
ZX-10R	2006 ▶	PM309B	BLACK	€ 158,00



■ ■ ■ license plate support

MODEL	YEAR	157x157 mm	175x130 mm	146x69.5 mm	PRICE
ZX-10R	'04-'05	PT301B1	PT301B2	PT301B3	€ 99,00
ZX-10R	2006 ▶	PT304B1	PT304B2	PT304B3	€ 99,00

KAWASAKI

kawasaki® zx-r 636





■ ■ ■ rear set control kit

MODEL	YEAR	CODE	COLOR	PRICE
ZX6-R	'03-'04	PE302B	NERO	€ 429,00
ZX6-R	'05-'06	PE310B	NERO	€ 429,00



■ ■ ■ license plate support

MODEL	YEAR	157x157 mm	175x130 mm	146x69.5 mm	PRICE
ZX-6 R	◀ 2004	PT300B1	PT300B2	PT300B3	€ 99,00
ZX-6 R	'05-'06	PT302B1	PT302B2	PT302B3	€ 99,00



■ ■ ■ Rizoma indicator light adapters (pair)

MODEL	YEAR	CODE	COLOR	PRICE
ZX-6 R	2005 ▶	FR252B	BLACK	€ 21,00



■ ■ ■ engine guard

MODEL	YEAR	CODE	COLOR	PRICE
ZX6-R	◀ 2002	PM301B	BLACK	€ 59,00
ZX6-R	'03-'04	PM303B	BLACK	€ 59,00
ZX9-R	◀ 2003	PM301B	BLACK	€ 59,00

KAWASAKI

kawasaki® er-6n





■ ■ ■ rear set control kit

MODEL	YEAR	CODE	COLOR	PRICE
ER-6N	2005 ▶	PE312B	BLACK	€ 429,00



■ ■ ■ passenger pegs

MODEL	YEAR	CODE	COLOR	PRICE
ER-6N	2005 ▶	PE570B	BLACK	€ 189,00

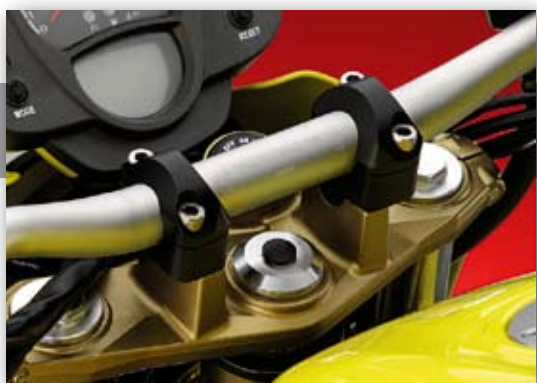

■ ■ ■ conical handlebar adapters

MODEL	YEAR	CODE	COLOR	PRICE
ER-6N	2005 ▶	AZ405B	BLACK	€ 99,00

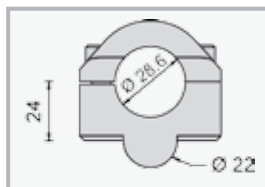

■ ■ ■ engine guard

MODEL	YEAR	CODE	COLOR	PRICE
ER-6N	2005 ▶	PM308B	BLACK	€ 59,00



■ ■ ■ license plate support

MODEL	YEAR	mm 157x157	mm 175x130	mm 146x69.5	PRICE
ER-6N	2005 ▶	PT301B1	PT301B2	PT301B3	€ 99,00

kawasaki® z750 / z1000





kawasaki® z750 / z1000



clip-on bars kit ■ ■ ■



MODEL	YEAR	CODE	COLOR	PRICE
Z1000	2003-2006	MA350D		€ 249,00



rear set control kit ■ ■ ■

MODEL	YEAR	CODE	COLOR	PRICE
Z750	2003-2006	PE301B	BLACK	€ 429,00
Z1000	2003-2006	PE300B	BLACK	€ 429,00

passenger pegs kit ■ ■ ■

MODEL	YEAR	CODE	COLOR	PRICE
Z1000	2003-2006	PE566AB	BLACK	€ 149,00





■ ■ ■ engine guard

MODEL	YEAR	CODE	COLOR	PRICE
Z750	2003-2006	PM304B	BLACK	€ 59,00



■ ■ ■ engine guard

MODEL	YEAR	CODE	COLOR	PRICE
Z1000	2003-2006	PM305A	NATURAL	€ 69,00



■ ■ ■ license plate support

MODEL	YEAR	mm 157x157	mm 175x130	mm 146x69.5	PRICE
Z750	2004 ▶	PT300B1	PT300B2	PT300B3	€ 99,00
Z1000	2003 ▶	PT300B1	PT300B2	PT300B3	€ 99,00
Z1000	2007 ▶	PT306B1	PT306B2	PT306B3	€ 99,00



KTM

ktm® 990 super duke





■ ■ ■ rear set control kit

MODEL	YEAR	CODE	COLOR	PRICE
SUPER DUKE	2005 ▶	PE470B	BLACK	€ 429,00



■ ■ ■ clutch cover

MODEL	YEAR	CODE	COLOR	PRICE
SUPER DUKE	2005 ▶	ZMD001A	BLACK	€ 199,00



■ ■ ■ left side cover

MODEL	YEAR	CODE	COLOR	PRICE
SUPER DUKE	2005 ▶	ZMD003B	BLACK	€ 89,00



■ ■ ■ license plate support

MODEL	YEAR	mm 157x157	mm 175x130	mm 146x69.5	PRICE
SUPER DUKE	2005 ▶	PT675B1	PT675B2	PT675B3	€ 99,00

MV AGUSTA

mv agusta® f4 - brutale





■ ■ ■ rear set control kit



MODEL	YEAR	CODE	COLOR	PRICE
BRUTALE 750	2002 ▶	PE430B	BLACK	€ 429,00
BRUTALE 910	2005 ▶	PE430B	BLACK	€ 429,00
F4 750	2002 ▶	PE430B	BLACK	€ 429,00
F4 1000	2002 ▶	PE430B	BLACK	€ 429,00



■ ■ ■ engine guard

MODEL	YEAR	CODE	COLOR	PRICE
BRUTALE 750	2002 ▶	PM430B	BLACK	€ 59,00
BRUTALE 910	2005 ▶	PM430B	BLACK	€ 59,00



■ ■ ■ license plate support

MODEL	YEAR	mm 157x157	mm 175x130	mm 146x69.5	PRICE
BRUTALE 750	2002 ▶	PT600B1	PT600B2	PT600B3	€ 99,00
BRUTALE 910	2005 ▶	PT600B1	PT600B2	PT600B3	€ 99,00

SUZUKI

suzuki® gsx-r 600 / 750 k6





■ ■ ■ rear set control kit



MODEL	YEAR	CODE	COLOR	PRICE
GSX-R 600	◀ 2005	PE158B	BLACK	€ 429,00
GSX-R 750	◀ 2005	PE158B	BLACK	€ 429,00
GSX-R 600	2006 ▶	PE165B	BLACK	€ 429,00
GSX-R 750	2006 ▶	PE165B	BLACK	€ 429,00

■ ■ ■ fairing indicator light adapters (inox)



MODEL	YEAR	CODE	COLOR	PRICE
GSX-R 600	2006 ▶	FR260H	INOX	€ 19,50
GSX-R 750	2006 ▶	FR260H	INOX	€ 19,50



■ ■ ■ fairing guard



MODEL	YEAR	CODE	COLOR	PRICE
GSX-R 600	2004-2005	PM159B	BLACK	€ 59,00
GSX-R 750	2004-2005	PM159B	BLACK	€ 59,00

■ ■ ■ fairing guard



MODEL	YEAR	CODE	COLOR	PRICE
GSX-R 600	2006 ▶	PM162B	BLACK	€ 159,00
GSX-R 750	2006 ▶	PM162B	BLACK	€ 159,00

■ ■ ■ license plate support



MODEL	YEAR	mm 157x157	mm 175x130	mm 146x69.5	PRICE
GSX-R 600	◀ 2005	PT401B1	PT401B2	PT401B3	€ 99,00
GSX-R 750	◀ 2005	PT401B1	PT401B2	PT401B3	€ 99,00
GSX-R 600	2006 ▶	PT403B1	PT403B2	PT403B3	€ 99,00
GSX-R 750	2006 ▶	PT403B1	PT403B2	PT403B3	€ 99,00

SUZUKI[®] gsx-r 1000





■ ■ ■ rear set control kit

MODEL	YEAR	CODE	COLOR	PRICE
GSX-R 1000	'01-'04	PE158B	BLACK	€ 429,00
GSX-R 1000	'05-'06	PE159B	BLACK	€ 429,00



■ ■ ■ engine guard

MODEL	YEAR	CODE	COLOR	PRICE
GSX-R 1000	'00-'04	PM159B	BLACK	€ 59,00
GSX-R 1000	'05-'06	PM160B	BLACK	€ 59,00



■ ■ ■ license plate support

MODEL	YEAR	mm 157x157	mm 175x130	mm 146x69.5	PRICE
GSX-R 1000	'03-'04	PT400B1	PT400B2	PT400B3	€ 99,00
GSX-R 1000	'05-'06	PT402B1	PT402B2	PT402B3	€ 99,00

SUZUKI® gsr 600





■ ■ ■ rear set control kit

MODEL	YEAR	CODE	COLOR	PRICE
GSR 600	2006 ▶	PE164B	BLACK	€ 429,00



■ ■ ■ passenger pegs kit

MODEL	YEAR	CODE	COLOR	PRICE
GSR 600	2006 ▶	PE572B	BLACK	€ 189,00



■ ■ ■ conical handlebar adapter

MODEL	YEAR	CODE	COLOR	PRICE
GSR 600	2006 ▶	AZ405B	BLACK	€ 99,00

SUZUKI® gsr 600

radiator cover ■ ■ ■



MODEL	YEAR	CODE	COLOR	PRICE
GSR 600	2006 ▶	RA335B	BLACK	€ 129,00



engine guard ■ ■ ■

MODEL	YEAR	CODE	COLOR	PRICE
GSR 600	2006 ▶	PM202B	BLACK	€ 59,00

stock rear indicator light adapters ■ ■ ■

MODEL	YEAR	CODE	PRICE
GSR 600	2006 ▶	FR280H	€ 21,00

Our license plate supports are supplied with Rizoma indicator light supports. FR280H is required for mounting stock indicator lights.





triumph® speed triple





■ ■ ■ rear set control kit

MODEL	YEAR	CODE	COLOR	PRICE
ALL	2002 ▶	PE450B	BLACK	€ 429,00



■ ■ ■ engine guard

MODEL	YEAR	CODE	COLOR	PRICE
ALL	2002 ▶	PM250B	NATURAL	€ 78,00



■ ■ ■ sprocket cover

MODEL	YEAR	CODE	COLOR	PRICE
ALL	2002 ▶	ZTS010A	NATURAL	€ 139,00

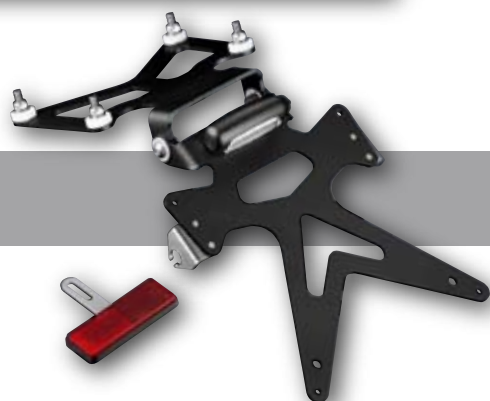

■ ■ ■ license plate support

MODEL	YEAR	mm 157x157	mm 175x130	mm 146x69.5	PRICE
ALL	2005 ▶	PT650B1	PT650B2	PT650B3	€ 99,00





■ ■ ■ rear set control kit

MODEL	YEAR	CODE	COLOR	PRICE
YZF R6	'03-'05	PE120B	BLACK	€ 429,00
YZF R6	2006 ▶	PE123B	BLACK	€ 429,00



■ ■ ■ fairing guard

MODEL	YEAR	CODE	COLOR	PRICE
YZF R6	◀ 2004	PM205B	BLACK	€ 59,00
YZF R6	2006 ▶	PM207B	BLACK	€ 59,00



■ ■ ■ license plate support

MODEL	YEAR	157x157 mm	175x130 mm	146x69.5 mm	PRICE
YZF R6	'02-'05	PT200B1	PT200B2	PT200B3	€ 99,00
YZF R6	2006 ▶	PT204B1	PT204B2	PT204B3	€ 99,00

Our license plate supports are supplied with Rizoma indicator light supports. FR270H is required for mounting stock indicator lights.

stock rear indicator adapter ■ ■ ■

MODEL	YEAR	CODE	PRICE (PAIR)
YZF R6	2006 ▶	FR270H	





■ ■ ■ rear set control kit

MODEL	YEAR	CODE	COLOR	PRICE
YZF R1	1998-2003	PE110B	BLACK	€ 429,00
YZF R1	2004-2006	PE111B	BLACK	€ 429,00



■ ■ ■ fairing guard

MODEL	YEAR	CODE	COLOR	PRICE
YZF R1	2004-2006	PM206B	BLACK	€ 59,00
YZF R1	◀ 2003	PM205B	BLACK	€ 59,00

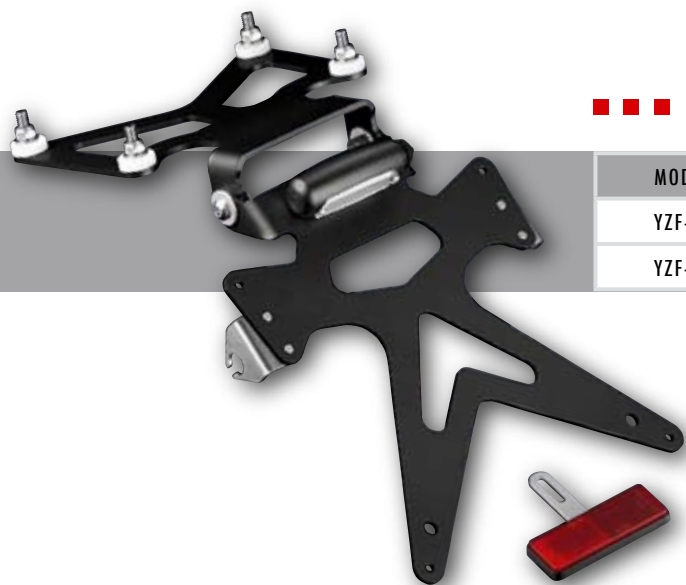

■ ■ ■ license plate support

MODEL	YEAR	157x157 mm	175x130 mm	146x69.5 mm	PRICE
YZF-R1	2002-2003	PT200B1	PT200B2	PT200B3	€ 99,00
YZF-R1	2004-2006	PT201B1	PT201B2	PT201B3	€ 99,00





■ ■ ■ rear set control kit

MODEL	YEAR	CODE	COLOR	PRICE
FZ1	2006 ▶	PE112B	BLACK	€ 429,00
FZ1 FAZER	2006 ▶	PE112B	BLACK	€ 429,00



■ ■ ■ conical handlebar adapters

MODEL	YEAR	CODE	COLOR	HEIGHT	PRICE
FZ1	2006 ▶	AZ408B	BLACK	42 mm	€ 89,00
FZ1	2006 ▶	AZ410B	BLACK	60 mm	€ 89,00
FZ1 FAZER	2006 ▶	AZ408B	BLACK	42 mm	€ 89,00
FZ1 FAZER	2006 ▶	AZ410B	BLACK	60 mm	€ 89,00



■ ■ ■ radiator cover

MODEL	YEAR	CODE	COLOR	PRICE
FZ1	2006 ▶	RA107A	NATURAL	€ 129,00
FZ1 FAZER	2006 ▶	RA107A	NATURAL	€ 129,00



■ ■ ■ engine guard

MODEL	YEAR	CODE	COLOR	PRICE
FZ1	2006 ▶	PM208B	BLACK	€ 59,00
FZ1 FAZER	2006 ▶	PM208B	BLACK	€ 59,00

side panels (rh, lh) ■ ■ ■

MODEL	YEAR	CODE	COLOR	PRICE
FZ1	2006 ▶	ZYF002A	NATURAL	€ 89,00
FZ1 FAZER	2006 ▶	ZYF002A	NATURAL	€ 89,00



sprocket cover ■ ■ ■

MODEL	YEAR	CODE	COLOR	PRICE
FZ1	2006 ▶	ZYF001A	NATURAL	€ 139,00
FZ1 FAZER	2006 ▶	ZYF001A	NATURAL	€ 139,00



chain guard ■ ■ ■

MODEL	YEAR	CODE	COLOR	PRICE
FZ1	2006 ▶	ZYF003A	NATURAL	€ 99,00
FZ1 FAZER	2006 ▶	ZYF003A	NATURAL	€ 99,00



license plate support ■ ■ ■

MODEL	YEAR	mm 157x157	mm 175x130	mm 146x69.5	PRICE
FZ1	2006 ▶	PT205B1	PT205B2	PT205B3	€ 99,00
FZ1 FAZER	2006 ▶	PT206B1	PT206B2	PT206B3	€ 99,00



Our license plate supports are supplied with Rizoma indicator light supports. FR270H is required for mounting stock indicator lights.

■ ■ ■ stock rear indicator light adapter

MODEL	YEAR	CODE	PRICE
FZ1	2006 ▶	FR270H	€ 21,00
FZ1 FAZER	2006 ▶	FR270H	€ 21,00



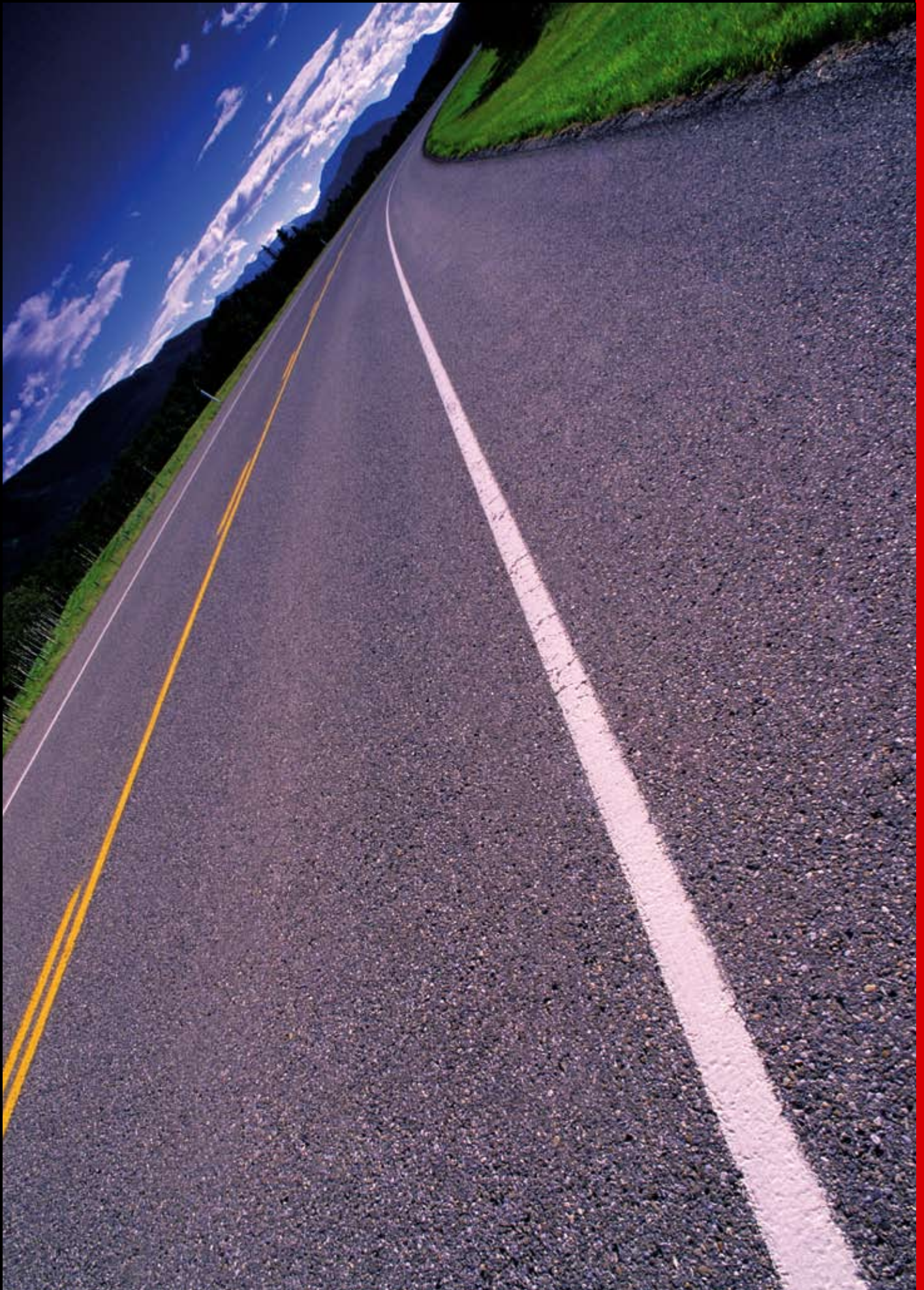

YAMAHA

yamaha® fazer





■ ■ ■ rear set control kit

MODEL	YEAR	CODE	COLOR	PRICE
FZ6	2004 ▶	PE108B	BLACK	€ 429,00
FZS1000	'01-'05	PE109B	BLACK	€ 429,00



■ ■ ■ radiator cover

MODEL	YEAR	CODE	COLOR	PRICE
FZ6	2004 ▶	RA106A	NATURAL	€ 99,00



■ ■ ■ engine guard

MODEL	YEAR	CODE	COLOR	PRICE
FZ6	◀ 2003	PM203B	BLACK	€ 59,00
FZ6	2004 ▶	PM202B	BLACK	€ 59,00
FZS1000	'01-'05	PM203B	BLACK	€ 59,00



■ ■ ■ license plate support

MODEL	YEAR	157x157 mm	75x130 mm	146x69.5 mm	PRICE
FZ6	2004 ▶	PT202B1	PT202B2	PT202B3	€ 99,00

YAMAHA

yamaha® mt-03





■ ■ ■ conical handlebar adapters



MODEL	YEAR	CODE	COLOR	PRICE
MT-03	2006 ▶	AZ402B	BLACK	€ 79,00
MT-03	2006 ▶	AZ402S	COOL GREY	€ 79,00

⚠ instrument adapter ZYM012A is required for mounting the handlebar adapters € 10,50



■ ■ ■ sprocket cover

MODEL	YEAR	CODE	COLOR	PRICE
MT-03	2006 ▶	ZYM010A	NATURAL	€ 69,00



■ ■ ■ license plate support with led tail light

MODEL	YEAR	157x157 mm	175x130 mm	146x69.5 mm	PRICE
MT-03	2006 ▶	PT203B1	PT203B2	PT203B3	€ 199,00

YAMAHA

yamaha® mt-01

RIZOMA® ACCESSORIES FOR MT-01 ARE EXCLUSIVELY DISTRIBUTED BY YAMAHA® THROUGH ITS OFFICIAL DEALERS.





CUSTOM

Accessories intended
for custom design:
a balance between elegance
and modernity,
sinuous shapes and treasured details
for a style that's unique.



HARLEY-DAVIDSON

harley-davidson® v-rod®







triple tree kit ■ ■ ■

MODEL	YEAR	CODE	COLOR	PRICE
VRSCA / B	ALL	PA258L	POLISHED	€ 669,00
VRSCA / B	ALL	PA258B	BLACK	€ 669,00



clip-on bars kit ■ ■ ■

MODEL	YEAR	CODE	COLOR	PRICE
VRSCA / B	ALL	MA460L	POLISHED	€ 549,00
VRSCA / B	ALL	MA460B	BLACK	€ 549,00



fork slider end covers ■ ■ ■

MODEL	YEAR	CODE	COLOR	PRICE
VRSCA / B	ALL	ZZH050L	POLISHED	€ 149,00
VRSCA / B	ALL	ZZH050B	BLACK	€ 149,00



swing arm caps ■ ■ ■

MODEL	YEAR	CODE	COLOR	PRICE
VRSCA / B	ALL	ZZH058L	POLISHED	€ 32,00
VRSCA / B	ALL	ZZH058B	BLACK	€ 32,00



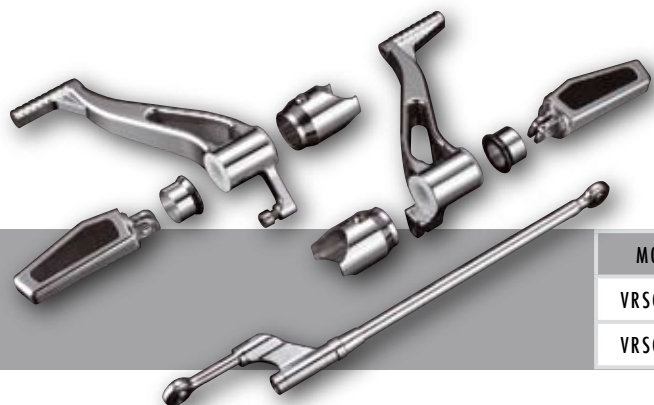

■ ■ ■ control kit



MODEL	YEAR	CODE	COLOR	PRICE
VRSCA / B	ALL	PE254L	POLISHED	€ 479,00
VRSCA / B	ALL	PE254B	BLACK	€ 479,00



■ ■ ■ pegs kit

MODEL	YEAR	CODE	COLOR	PRICE
VRSCA / B	ALL	PE601L	POLISHED	€ 89,00
VRSCA / B	ALL	PE601B	BLACK	€ 89,00

⚠ THIS SUPPORT NEEDS ONE PEG ADAPTER. (SEE TABLE BELOW)



■ ■ ■ license plate support complete with license plate light and reflector kit

MODEL	YEAR	CODE	COLOR	PRICE
VRSCA / B *	ALL	PT550L1	POLISHED	€ 169,00
VRSCA / B *	ALL	PT550B1	BLACK	€ 169,00

⚠ * EXCEPT STREET ROD MODELS



■ ■ ■ license plate support

MODEL	YEAR	157x157 mm	75x130 mm	146x69.5 mm	PRICE
VRSCA / B	2004 ▶	PT551B1	PT551B2	PT551B3	€ 119,00

ADAPTERS

■ ■ ■ passenger pegs adapters

MODEL	YEAR	CODE	PRICE
VRSCA / B	ALL	PE730A	€ 22,00



pulley ■ ■ ■

MODEL	YEAR	CODE	COLOR	PRICE
VRSCA / B	ALL	ZZH060L	POLISHED	€ 549,00
VRSCA / B	ALL	ZZH060B	BLACK	€ 549,00

 Doesn't fit with OEM belt cover



rear indicator light adapters (pair) ■ ■ ■

MODEL	YEAR	CODE	COLOR	PRICE
VRSCA / B	ALL	FR203L	POLISHED	€ 59,00
VRSCA / B	ALL	FR203B	BLACK	€ 59,00



belt cover ■ ■ ■

MODEL	YEAR	CODE	COLOR	PRICE
VRSCA / B	ALL	ZZH054L	POLISHED	€ 189,00
VRSCA / B	ALL	ZZH054B	BLACK	€ 189,00





■ ■ ■ shock absorber covers

MODEL	YEAR	CODE	COLOR	PRICE
VRSCA	ALL	ZZH056L	POLISHED	€ 189,00
VRSCA	ALL	ZZH056B	BLACK	€ 189,00



■ ■ ■ indicator light clamps

MODEL	YEAR	CODE	COLOR	PRICE
VRSCA / B	ALL	FS006L	POLISHED	€ 69,00



honda® shadow / black widow

triple tree kit ■ ■ ■

MODEL	YAER	CODE	RAKE	PRICE
BLACK WIDOW	ALL	PA058L	0°	€ 549,00

RAKE	0°
CENTRE DISTANCE	250 mm
THICKNESS	35/40 mm



triple tree kit ■ ■ ■

MODEL	YAER	CODE	RAKE	PRICE
VT600 SHADOW	ALL	PA052L	5°	€ 549,00

RAKE	5°
CENTRE DISTANCE	250 mm
THICKNESS	35/40 mm





■ ■ ■ lever blades kit

MODEL	YEAR	CODE	PRICE
VT600 SHADOW	ALL	ZHS054L	€ 119,00
VT750 SHADOW	ALL	ZHS054L	€ 119,00
BLACK WIDOW/SPIRIT	ALL	ZHS054L	€ 119,00



■ ■ ■ forward control kit

MODEL	YEAR	CODE	FORWARD	PRICE
VT750 SHADOW	◀ 2003	PE056L	100 mm	€ 429,00



■ ■ ■ forward control kit

MODEL	YEAR	CODE	FORWARD	PRICE
VT125 SHADOW	ALL	PE050L	100 mm	€ 299,00
VT600 SHADOW	ALL	PE054L	80 mm	€ 429,00
BLACK WIDOW/SPIRIT	ALL	PE052L	140 mm	€ 449,00



■ ■ ■ passenger peg kit

MODEL	YEAR	CODE	PRICE
VT600 SHADOW	◀ 1997	PE500L	€ 79,00
VT600 SHADOW	1998 ▶	PE502L	€ 79,00
VT750 SHADOW	ALL	PE502L	€ 79,00
BLACK WIDOW/SPIRIT	ALL	PE500L	€ 79,00

YAMAHA

yamaha® wild star





■ ■ ■ speedo cover

MODEL	YEAR	CODE	PRICE
WILD STAR/ROAD STAR	ALL	ZYW020L	€ 94,00



■ ■ ■ front cover

MODEL	YEAR	CODE	PRICE
WILD STAR/ROAD STAR	ALL	ZYW023L	€ 179,00



■ ■ ■ floorboard kit

MODEL	YEAR	CODE	PRICE
WILD STAR/ROAD STAR	ALL	PE104L	€ 529,00



SHIFTER ROD INCLUDED

fuel pump cover ■ ■ ■

MODEL	YEAR	CODE	PRICE
WILD STAR/ROAD STAR	ALL	ZYW014L	€ 122,00



case cover - right ■ ■ ■

MODEL	YEAR	CODE	PRICE
WILD STAR/ROAD STAR	ALL	ZYW009L	€ 59,00



ADAPTERS

front indicator light adapters ■ ■ ■

MODEL	YEAR	CODE	PRICE
WILD STAR/ROAD STAR	ALL	ZYW027L	€ 14,00





YAMAHA

yamaha® drag star





■ ■ ■ triple tree kit

MODEL	YEAR	CODE	PRICE
650	ALL	PA104L	€ 549,00
1100	ALL	PA108L	€ 549,00



RAKE	5°
CENTRE DISTANCE	270 mm
THICKNESS	40 mm



■ ■ ■ front master cylinder cover

MODEL	YEAR	CODE	PRICE
650/1100	ALL	ZYD008L	€ 38,00



forward control kit ■ ■ ■

MODEL	YEAR	CODE	FORWARD	PRICE
650	◀ 2003	PE100L	100 mm	€ 429,00

EXCEPT CLASSIC MODEL



forward control kit ■ ■ ■

MODEL	YEAR	CODE	FORWARD	PRICE
1100	ALL	PE102L	110 mm	€ 469,00

EXCEPT CLASSIC MODEL



passenger pegs ■ ■ ■

MODEL	YEAR	CODE	PRICE
650/1100	ALL	PE520L	€ 79,00





front brake caliper cover

MODEL	YEAR	CODE	PRICE
650	ALL	ZYD010L	€ 69,00



regulator cover

MODEL	YEAR	CODE	PRICE
650	ALL	ZYD016L	€ 59,00



speedo cover

MODEL	YEAR	CODE	PRICE
1100	ALL	ZYD068L	€ 89,00

GRIPS



The cable adapter is made into each grip, and can be mounted on any handlebar of 25.4 mm (1 inch)

elicoidale ■ ■ ■

CODE	COLOR	PRICE
GR003L	POLISHED	€ 89,00



lineare ■ ■ ■

CODE	COLOR	PRICE
GR001L	POLISHED	€ 79,00



sky hole ■ ■ ■

CODE	COLOR	PRICE
GR009L	POLISHED	€ 89,00
GR009B	BLACK	€ 89,00



RISERS / INDICATOR LIGHT CLAMPS



The riser has 2 x 12 mm screws included

■ ■ ■ RISER Ø 25,4 mm

CODE	COLOR	PRICE
AZ012L	POLISHED	€ 119,00
AZ010L	POLISHED	€ 119,00

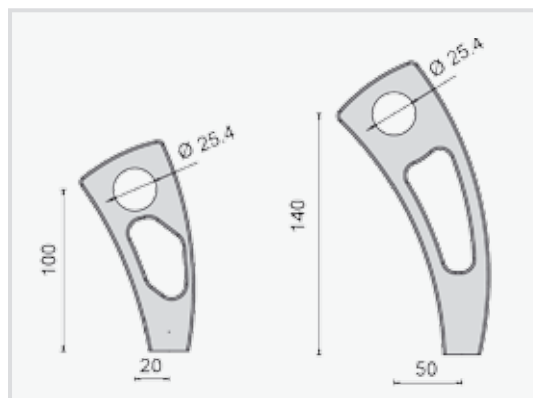

■ ■ ■ indicator light clamps

CODE	COLOR	DIAMETER	PRICE
FS005L	POLISHED	39 TO 43 mm	€ 69,00
FS006L	POLISHED	49 mm	€ 69,00
FS007L	POLISHED	50 TO 56 mm	€ 69,00



indicator lights, see page 42



HANDLEBAR WATCHES

 Handlebar watches can be easily mounted on handlebars from 22mm to 27mm in diameter.

handlebar watch ■ ■ ■

CODE	COLOR	PRICE
CL003L	POLISHED	€ 99,00

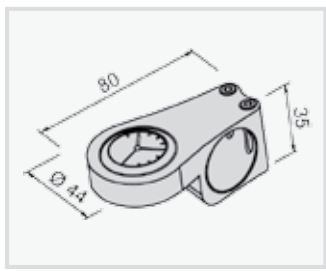

handlebar watch ■ ■ ■

CODE	COLOR	PRICE
CL005L	POLISHED	€ 79,00

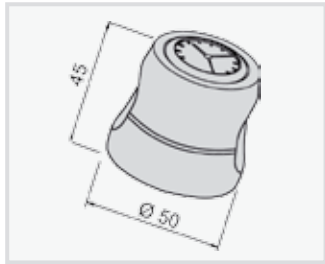

handlebar watch ■ ■ ■

CODE	COLOR	PRICE
CL008L	POLISHED	€ 69,00



